



**DIN COMPONENTS:
105 - 687.65 SERIES incl.
MERCEDES, SCANIA & VOLVO**

CONTENTS

Reference Drawings	Pg 4
105 Series, 106 Series	Pg 6
107 Series	Pg 7
109 Series	Pg 8
110 Series	Pg 9
112 Series, 113 Series, 115 Series,	Pg 10
204 Series, 473.30 Series, 287.00 Series	Pg 11
287.10 Series, 287.30 Series, 587.10 Series	Pg 12
587.15 Series	Pg 13
587.20 Series	Pg 14
587.30 Series	Pg 15
587.36 Series	Pg 16
587.42 Series	Pg 17
587.50 Series, 587.55 Series	Pg 18
687.15 Series	Pg 19
687.20 Series	Pg 20
687.25 Series	Pg 21
687.30 Series	Pg 22
687.35 Series	Pg 23
687.40 Series	Pg 24
687.45 Series	Pg 26
687.55 Series	Pg 27
687.60 Series	Pg 28
687.65 Series, Foden Steering Shafts	Pg 29
Mercedes 286.22 Series, Mercedes 385.00 Series	Pg 30
Mercedes 186.37 Series, Mercedes 385.60 Series	Pg 31
Mercedes 385.65 Series	Pg 32
Scania P300 Series, Scania T60 Series	Pg 33
Scania P400 Series	Pg 34
Scania P500 Series	Pg 35
Scania P600 Series	Pg 36
Volvo 300 Series	Pg 37
Volvo 400 Series	Pg 38
Volvo 500 Series	Pg 39

PLEASE CONTACT US TO CONFIRM AVAILABILITY OF LISTED COMPONENTRY - OTHER PARTS & SERIES NOT SHOWN MAY BE AVAILABLE ON APPLICATION - PLEASE ENQUIRE.

REFERENCE DRAWINGS

COMPANION FLANGES

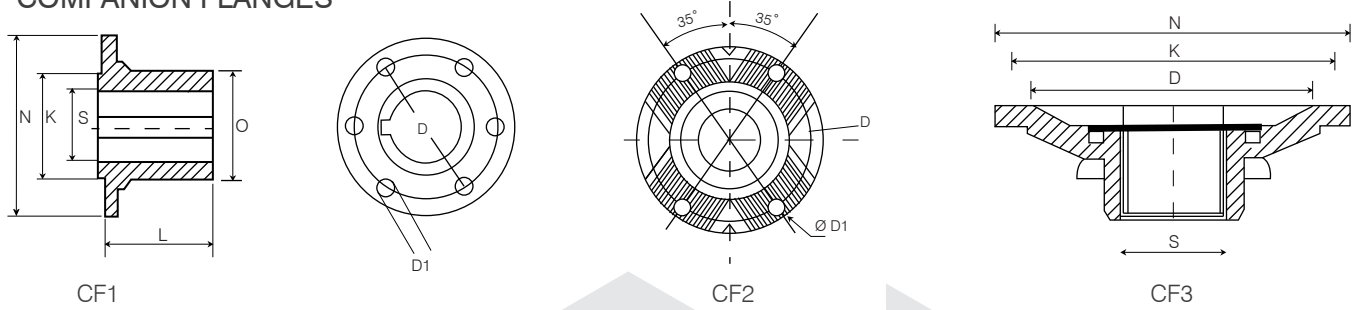

FLANGE YOKES

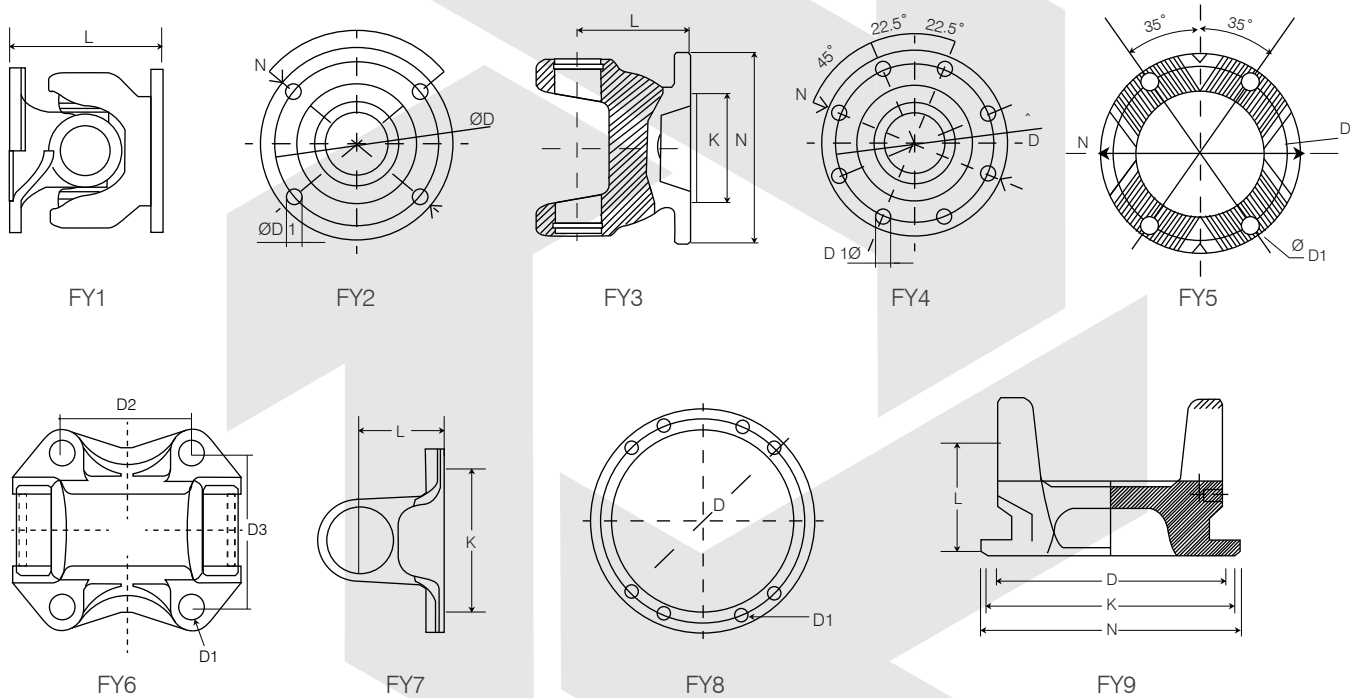

SLIP SETS

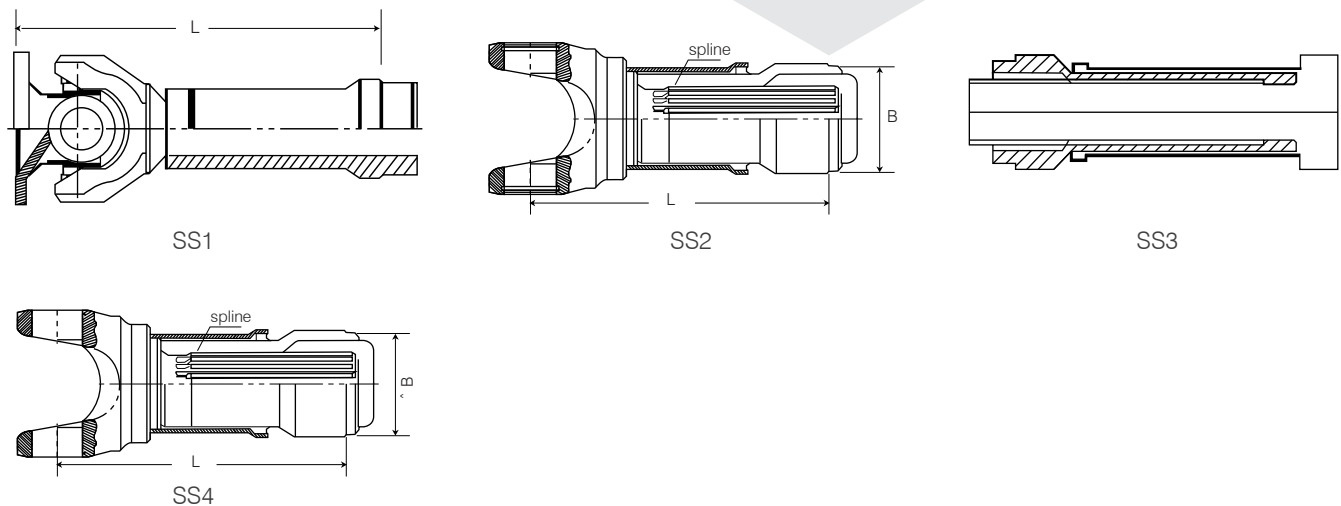

REFERENCE DRAWINGS

TUBE YOKES

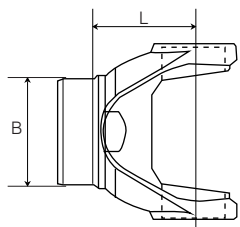

TY1

CENTRE YOKES

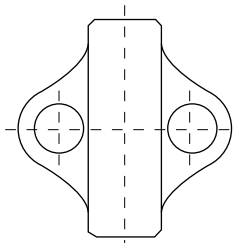

CY1

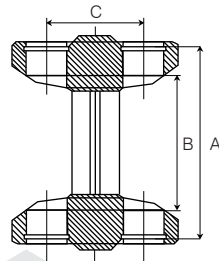

CY2

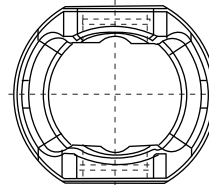

CY3

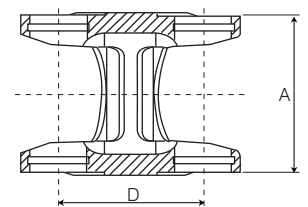

CY4

END YOKES

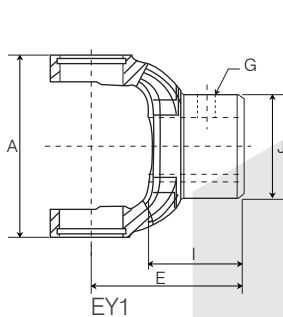

EY1

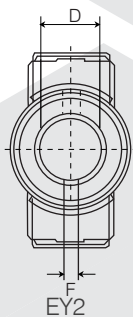

EY2



EY3

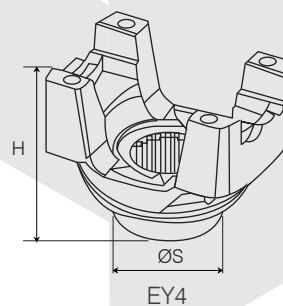

EY4

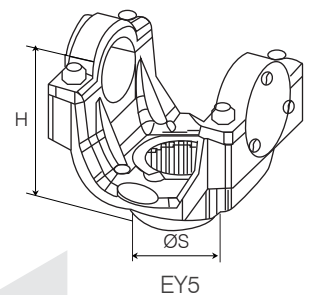

EY5

MIDSHIP STUBS

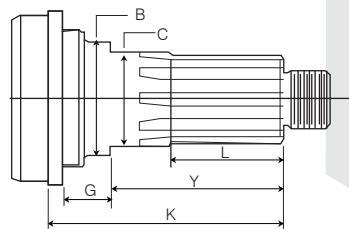

MS1

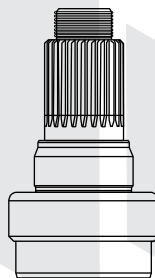

MS2

MIDSHIP C/BEARING ASSEMBLY

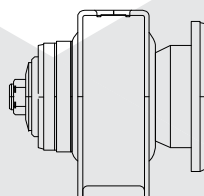

MCB1

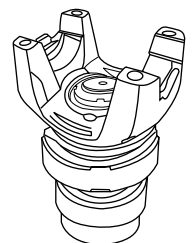
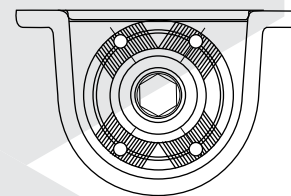

MCB2

DRIVESHAFT & SHORT COUPLE SETS

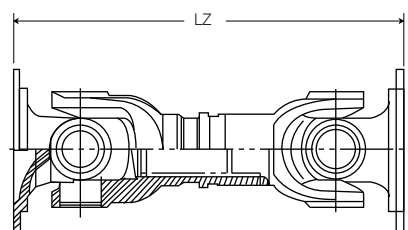

DS1

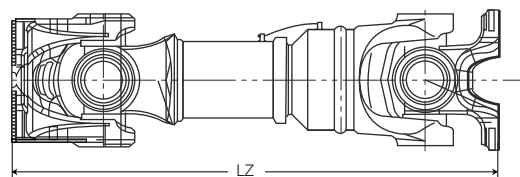

DS2

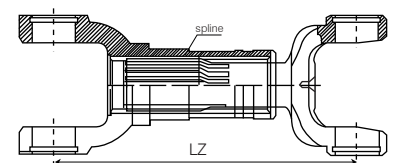

DS3

105 SERIES - 17.00 X 41.00 MM

SLIP SETS

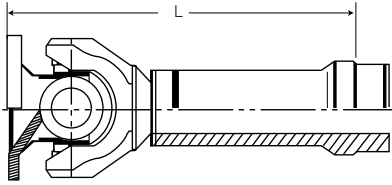

FIXED END

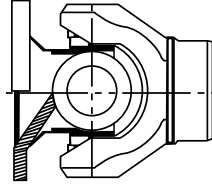

SHORT COUPLE SETS

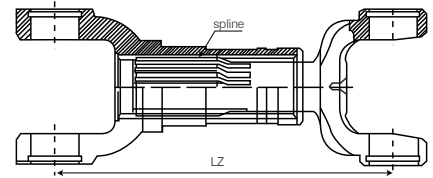

PART NO	ITEM DESCRIPTION	NOTES
UNIVERSAL JOINTS		
802024	105 SERIES 17 X 41	
SLIP SETS		
105-6-5845	105 SERIES SLIP SET 58DIN - L = 150MM INCL. FLANGE	
FIXED END		
105-7-5845	105 SERIES - 58DIN, 4M5	
SHORT COUPLE SETS		
0-105-081-101	105 SERIES SHORT COUPLED LZ = 105MM	

106 SERIES - 19.00 X 48.00 MM

DOUBLE FLANGE COUPLING

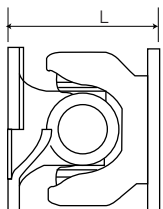

SLIP SETS

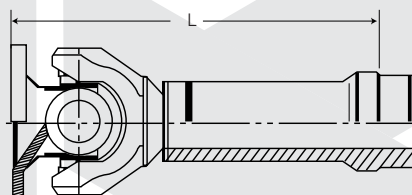

TUBE YOKES

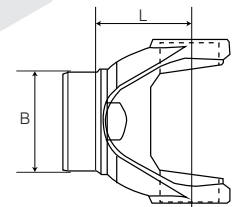

PART NO	ITEM DESCRIPTION	NOTES
UNIVERSAL JOINTS		
U-901C	106 SERIES 19 X 48 CIRCLIP	
U-901S	106 SERIES 19 X 48 STAKED	
U-901SL	106 SERIES 19 X 48 STAKED - GREASABLE	
FLANGE YOKES		
0-106-400-001	106 SERIES 65MM DOUBLE FLANGE COUPLING	
SLIP SETS		
106-6-6546	106 SERIES 65DIN - L = 165MM INCL. FLANGE, 4 X 6 MM	
106-6-6566	106 SERIES 65DIN - L = 165MM INCL. FLANGE, 6 X 6 MM	
TUBE YOKES		
106-28-001	106 SERIES - 32 X 1.5 TUBE, L = 45MM	

106 SERIES - 19.00 X 48.00 MM

FIXED END

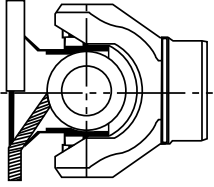

END YOKES

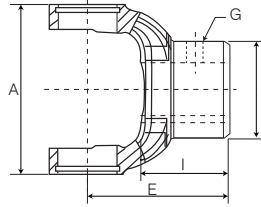

SHORT COUPLE SETS

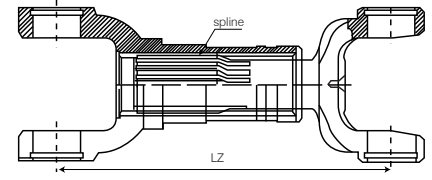

PART NO	ITEM DESCRIPTION	NOTES
FIXED END		
106-7-6546	106 SERIES FIXED END 65 DIN, 4M6	
END YOKES		
106-4-25M	106 SERIES - 25MM BORE & KEY	
106-4-2514	106 SERIES - 25MM 14SPL, L = 60MM	
SHORT COUPLE SETS		
0-106-081-101	106 SERIES SHORT COUPLED, LZ = 116MM C - C	

107 SERIES - 22.00 X 58.00 MM

COMPANION FLANGES

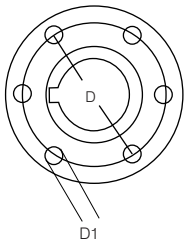

FLANGE YOKES

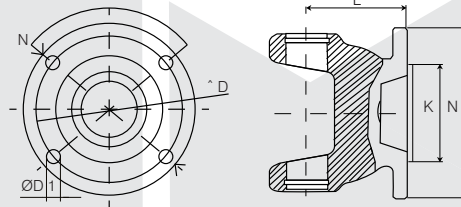

SLIP SETS

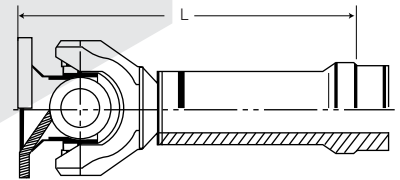

PART NO	ITEM DESCRIPTION	NOTES
UNIVERSAL JOINTS		
802004	107 SERIES 22 X 58	
802004-1A	107 SERIES 22 X 58 - GREASE IN CAP	
COMPANION FLANGE		
107-1-7566-30M	107 SERIES DIN75, 6 X 6MM HOLES, 30MM BORE, 8MM KEY	
FLANGE YOKES		
107-2-7548	107 SERIES DIN75 - N = 75MM, D = 62MM, D1 = 8MM (X 4), K = 42MM	
SLIP SETS		
107-6-500SFS	107 SERIES SLIP SET FOR STEERING SHFT - SEMIFINISHED, L = 500MM	
107-6-7548	107 SERIES SLIP SET C/W WEINIG FLANGE	
107-6-7548SFS	107 SERIES SLIP SET C/W WEINIG FLANGE - SEMIFINISHED	
107-6-7566	107 SERIES SLIP SET DIN75 - L = 187MM INCL. FLANGE	

107 SERIES - 22.00 X 58.00 MM

FIXED END

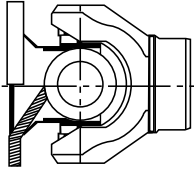

END YOKES

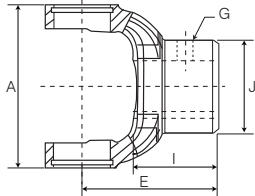

DRIVESHAFTS / SHORT COUPLE SETS

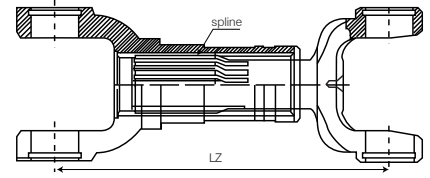
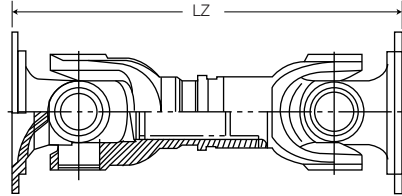

PART NO	ITEM DESCRIPTION	NOTES
FIXED END		
107-2-7500	107 SERIES DIN75 4M8 80°/ 100°	
107-7-7566	107 SERIES DIN75, 6M6	
END YOKES		
107-4-30M	107 SERIES 30MM BORE & KEY	
DRIVESHAFTS & SHORT COUPLE SETS		
107-03-200	107 SERIES DIN75 LZ = 200MM	WOOD PLANER
107-03-250	107 SERIES DIN75 6 X 6, LZ = 250MM	
107-03-178	107 SERIES SHORT COUPLED, LZ = 178MM C-C CLOSED	

109 SERIES - 28.50 X 70.90 MM

FLANGE YOKES

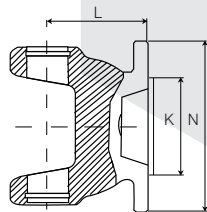
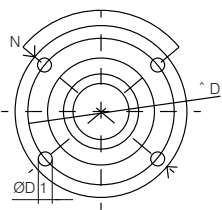

SLIP SETS

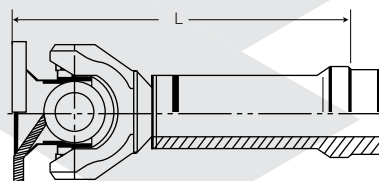

PART NO	ITEM DESCRIPTION	NOTES
UNIVERSAL JOINTS		
802039	109 SERIES 28.5 X 70.9	
802005	109 OLD SERIES 28 X 71.5	LADA
FLANGE YOKES		
109-2-9048	109 SERIES DIN90 - N = 90.00MM, D = 74.50MM, D1 = M8 (X 4), K = 47.00MM	
SLIP SETS		
109-6-175SFS	109 SERIES SLIP SET - L = 175MM	SEMI-FINISHED
109-6-9048	109 SERIES SLIP SET - L = 225MM, FLANGE = 90 X 4 X 8	
109-6-10068	109 SERIES SLIP SET - L = 225MM, FLANGE = 100 X 6 X 8	

109 SERIES - 28.50 X 70.90 MM

FIXED END

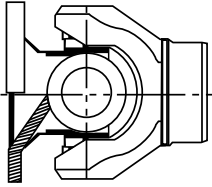

SHORT COUPLE SETS

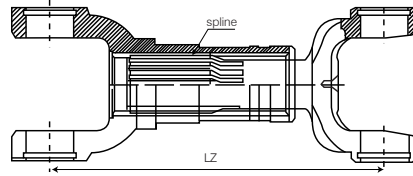

PART NO	ITEM DESCRIPTION	NOTES
FIXED END		
109-7-9048	109 SERIES, FLANGE = 90 X 4 X 8	
109-7-10068	109 SERIES, FLANGE = 100 X 6 X 8	
SHORT COUPLE SETS		
109-03-166	109 SERIES - 32MM X 14SPL - LZ = 166MM	

110 SERIES - 30.00 X 83.00 MM

SLIP SETS

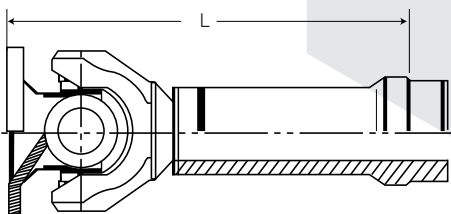

FIXED END

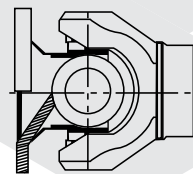

PART NO	ITEM DESCRIPTION	NOTES
UNIVERSAL JOINTS		
802006	110 SERIES 30 X 83	
802006-011R	110 SERIES 30 X 83 - LUBE IN CUP CIRCUMFERENCE	
802006-1A	110 SERIES 30 X 83 - LUBE IN END OF CUP	
SLIP SETS		
110-6-10068	110 SERIES SLIP SET - L = 240MM INCL. FLANGE, 100DIN	
FIXED END		
110-7-10068	110 SERIES 100DIN, 6M8	

112 SERIES - 35.00 X 97.00 MM

FLANGE YOKES

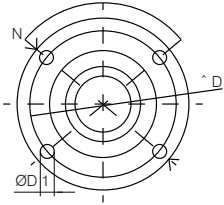

DRIVESHAFTS / SHORT COUPLE SETS

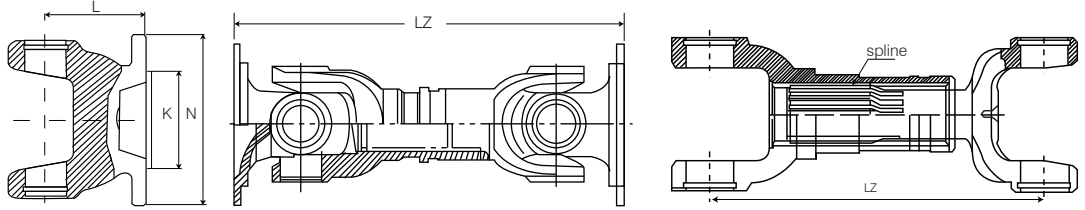

PART NO	ITEM DESCRIPTION	NOTES
UNIVERSAL JOINTS		
802040	112 SERIES 35 X 97	
802007	112 OLD SERIES 34 X 97	
FLANGE YOKES		
112-2-1410	112 SERIES SAE 1410 FACE - N = 116.00MM, D = 95.25MM, D1 = 11.20MM, K = 68.00MM	
DRIVESHAFTS & SHORT COUPLE SETS		
112-02-001	112 SERIES 120DIN, LZ = 950MM	
112-03-310	112 SERIES SHORT COUPLED, LZ = 310MM	

113 SERIES - 38.00 X 106.00 MM

PART NO	ITEM DESCRIPTION	NOTES
UNIVERSAL JOINTS		
802022	113 SERIES 38 X 106	

115 SERIES - 42.00 X 123.00 MM

PART NO	ITEM DESCRIPTION	NOTES
UNIVERSAL JOINTS		
802011	115 SERIES 42 X 123	

204 SERIES - 14.00 X 36.00 MM

SLIP SETS

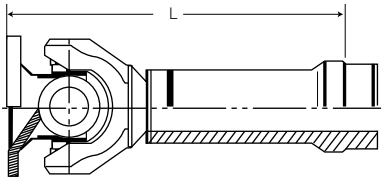

END YOKES

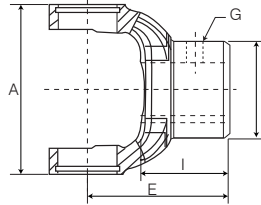

PART NO	ITEM DESCRIPTION	NOTES
UNIVERSAL JOINTS		
802037	204 SERIES 14 X 36	
END YOKES		
204-04-001	204 SERIES DIN PILOT BORE	

473.30 SERIES - 22.00 X 58.90 MM

PART NO	ITEM DESCRIPTION	NOTES
UNIVERSAL JOINTS		
U-166	473.30 SERIES 22 X 58.9	

287.00 SERIES - 26.00 X 69.80 MM

PART NO	ITEM DESCRIPTION	NOTES
UNIVERSAL JOINTS		
U-741	287.00 SERIES 26 X 69.8	
U-741S	287.00 SERIES 26 X 69.8, LFL	
TUBE YOKES		
28720-26-001	287.00 SERIES TUBE YOKE - TO SUIT 60 X 2MM TUBE	
YOKE SHAFTS		
28720-82-001	287.00 SERIES YOKE SHAFT, L = 194MM, SUIT 30MM BEARING	

287.00 SERIES - 26.00 X 69.80 MM

PART NO	ITEM DESCRIPTION	NOTES
SPLINED SLEEVE		
28720-23-001	287.00 SERIES SPLINED SLEEVE TO SUIT 60 X 2MM TUBE	
SMALL PARTS		
28720-90-001	287.00 SERIES RUBBER GAITER	

287.10 SERIES - 30.00 X 81.80 MM

PART NO	ITEM DESCRIPTION	NOTES
UNIVERSAL JOINTS		
U-742	287.10 SERIES 30 X 81.8	

287.30 SERIES - 44.00 X 124.80 MM

PART NO	ITEM DESCRIPTION	NOTES
UNIVERSAL JOINTS		
U-746	287.30 SERIES 44 X 124.8	

587.10 SERIES - 35.00 X 96.80 MM

PART NO	ITEM DESCRIPTION	NOTES
UNIVERSAL JOINTS		
U-743	587.10 SERIES 35 X 96.8	

587.15 SERIES - 42.00 X 104.50 MM

FLANGE YOKES

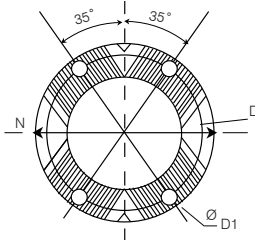
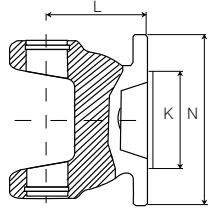
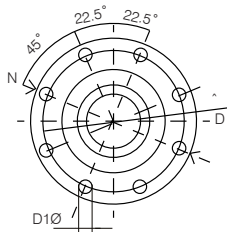

SLIP SETS

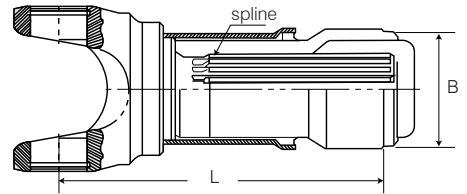

TUBE YOKES

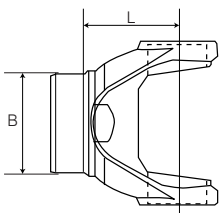

SHORT COUPLE SETS

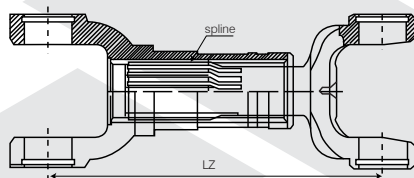

PART NO	ITEM DESCRIPTION	NOTES
UNIVERSAL JOINTS		
K5-A622	587.15 SERIES 42 X 104.5	
K5-A622S	587.15 SERIES 42 X 104.5	LFL
FLANGE YOKES		
58715-02731	587.15 SERIES - N = 120MM, D = 101.50MM, D1 = M10 (X 8), K = 75.00MM, L = 75MM	
58715-023883	587.15 SERIES 120KV UNIMOG - N = 120MM, D = 100.00MM, D1 = 13.00 (X 4), L = 75MM	
58715-02130810	587.15 SERIES - N = 130MM, D = 112.00MM, D1 = M10 (X 8), K = 82.50	
58715-02150	587.15 SERIES - N = 150MM, D = 130.00MM, D1 = M12 (X 8), K = 90.00MM, L = 75MM	
58715-02150B	587.15 SERIES - N = 150MM, L = 65MM	BLANK
58715-021510	587.15 SERIES 1510 PATTERN - N = 146.00MM, D = 120.65MM, D1 = 12.70MM, K = 95.20MM	
58715-02IS9770	587.15 SERIES ISUZU - D2 = 97MM, D3 = 70MM, K = 90MM	
MIDSHIP C/BEARING ASSEMBLIES		
58715-8-IS9770	587.15 SERIES ISUZU ASSEMBLY TO SUIT 45MM BEARING	
SLIP SETS		
58715-6-001	587.15 SERIES SLIP SET - L = 275MM	
58715-949	587.15 SERIES DUST COVER	
TUBE YOKES		
58715-26-001	587.15 SERIES - 80MM TUBE	
SHORT COUPLE SETS		
58715-03-255	587.15 SERIES SHORT COUPLED LZ = 255MM	
58715-03-345	587.15 SERIES SHORT COUPLED LZ = 345MM	

587.20 SERIES - 48.00 X 116.50 MM

FLANGE YOKES

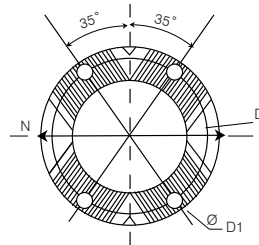
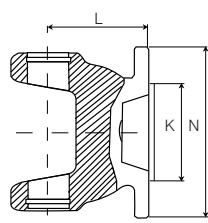
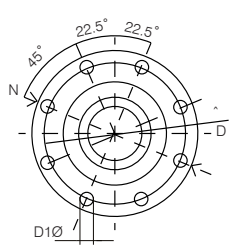

SLIP SETS

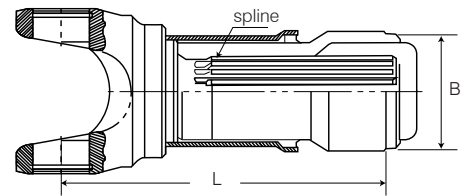

TUBE YOKES

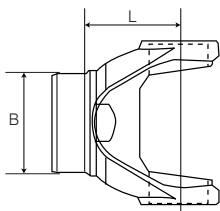

FIXED END

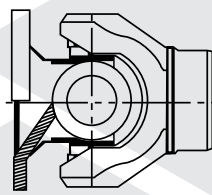

SHORT COUPLE SETS

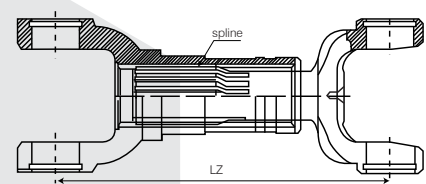

PART NO	ITEM DESCRIPTION	NOTES
UNIVERSAL JOINTS		
U-767	587.20 SERIES 48 X 116.5	
U-767S	587.20 SERIES 48 X 116.5	LFL
FLANGE YOKES		
58720-02150000	587.20 SERIES - N = 150.00MM, L = 80MM	BLANK
58720-02729	587.20 SERIES - N = 150.00MM, D = 130.00MM, D1 = M12 (X 8), K = 90.00MM, L = 86MM	
58720-021600	587.20 SERIES 1610 BOLTING - N = 174.50MM, D = 155.50MM, D1 = 9.53MM (X 8), K = 168.25MM	
58720-0201070	587.20 SERIES 120KV UNIMOG - N = 120.00MM, D = 90.00MM, D1 = 13.00MM (X 4)	
SLIP SETS		
58720-6-001	587.20 SERIES SLIP SET, L = 315MM	
58720-950	587.20 SERIES DUST COVER	
TUBE YOKES		
58720-26729	587.20 SERIES - 85MM TUBE	
FIXED END		
58720-7-1610	587.20 SERIES FIXED END 1610 BOLTING	
CENTRE BEARINGS		
CB-55200	587.20 SERIES 55MM X 36MM BRG, BHC = 200MM	
SHORT COUPLE SETS		
58720-03-375	587.20 SERIES SHORT COUPLED, LZ = 375MM CLOSED	
DOUBLE CARDAN PARTS		
58720-1610DC	587.20 SERIES DOUBLE CARDAN ASSY COMPLETE TO SUIT 1610	
SPLINED BAR / SPLINED SLEEVES		
58720-342C	587.20 SERIES SEMI-FINISHED SPLINE SET	
58720-552520	587.20 SERIES SEMI-FINISHED SPLINES - LONG, LZ = 700MM	

587.30 SERIES - 52.00 X 133.00 MM

FLANGE YOKES

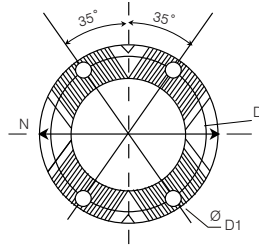
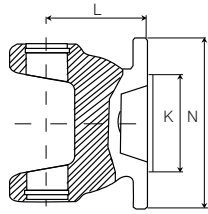
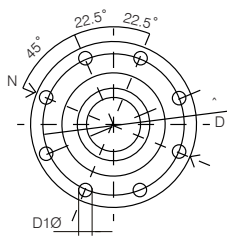

SLIP SETS

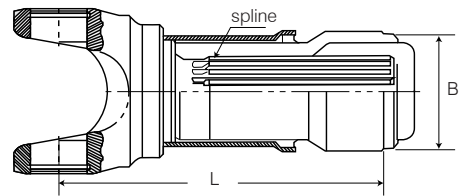

TUBE YOKES

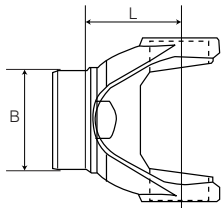

SHORT COUPLE SETS

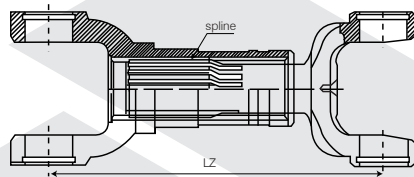

PART NO	ITEM DESCRIPTION	NOTES
UNIVERSAL JOINTS		
U-756	587.30 SERIES 52 X 133	
FLANGE YOKES		
58730-02759	587.30 SERIES - N = 150MM, D = 130.00MM, D1 = M12 (X 8), K = 90.00MM, L = 90MM	
58730-02150413	587.30 SERIES 150KV - N = 150MM, D = 130.00MM, D1 = 13.00 (X 4), L = 85MM	
58730-02180B	587.30 SERIES - N = 180.00MM	BLANK
58730-02748	587.30 SERIES - N = 180.00MM, D = 155.50MM, D1 = M14 (X 8), L = 92MM	
58730-02180415	587.30 SERIES 180KV - N = 180MM, D = 150.00MM, D1 = M15 (X 4), L = 95MM	
58730-02225B	587.30 SERIES - N = 225MM	BLANK
58730-021600	587.30 SERIES 1610 BOLTING - N = 174.50MM, D = 155.50MM, D1 = 9.53MM (X 8), K = 168.25MM	
58730-02779	587.30 SERIES 1810 BOLTING - N = 203.00MM, D = 184.20MM, D1 = 11.13MM (X 12), K = 196.90MM	
SLIP SETS		
58730-6-001	587.30 SERIES SLIP SET, L = 325MM	
58730-947	587.30 SERIES DUST COVER	
TUBE YOKE		
58730-26-001	587.30 SERIES 90MM TUBE	
CENTRE BEARINGS		
CB-55200	587.30 SERIES 55MM X 36MM BRG, BHC = 200MM	
SHORT COUPLE SETS		
58730-03-257	587.30 SERIES SHORT COUPLED, LZ = 257MM	
58730-03-390	587.30 SERIES SHORT COUPLED, LZ = 390MM CLOSED	
SPLINED BAR / SPLINED SLEEVES		
58730-652524	587.30 SERIES SPLINED BAR SET, L = 700MM	

587.36 SERIES - 57.00 X 144.00 MM

FLANGE YOKES

SLIP SETS

TUBE YOKES

CENTRE YOKES

SHORT COUPLE SETS

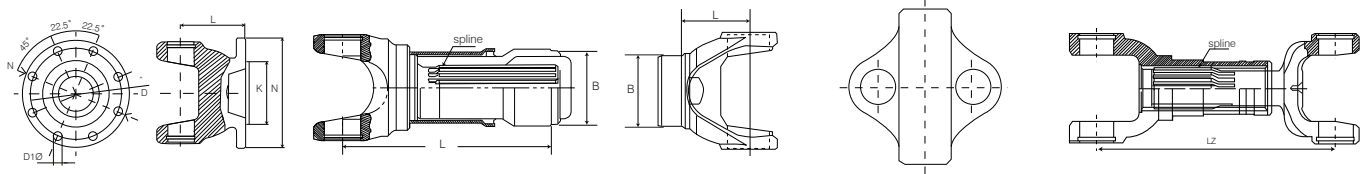

PART NO	ITEM DESCRIPTION	NOTES
UNIVERSAL JOINTS		
U-813	587.36 SERIES 57 X 144	
U-813S	587.36 SERIES 57 X 144	LFL
FLANGE YOKES		
58736-02180B	587.36 SERIES 180DIN - N = 180MM	BLANK
58736-02748	587.36 SERIES - N = 180.00MM, D = 155.50MM, D1 = M14 (X 8), K = 110.00MM, L = 85MM	
58736-02762	587.36 SERIES - N = 180.00MM, D = 155.50MM, D1 = M16 (X 8), K = 110.00MM, L = 95MM	
58736-02225B	587.36 SERIES - N = 225MM	BLANK
58736-02225816	587.36 SERIES - N = 225MM, D = 196.00MM, D1 = M16 (X 8), K = 140.00MM	
58736-021700	587.36 SERIES 1710 BOLTING - N = 203.20MM, D = 184.20MM, D1 = 9.50MM (X 8), K = 196.90MM	
58736-021800	587.36 SERIES 1810 BOLTING - N = 203.00MM, D = 184.20MM, D1 = 11.13MM (X 12), K = 196.90MM	
10753	587.36 SERIES DOUBLE CARDAN - N = 180.00MM, D = 155.50MM, D1 = M14 (X 8), K = 110.00MM	
SLIP SETS		
58736-6-001	587.36 SERIES SLIP SET, L = 330MM	
58736-547	587.36 SERIES SEAL	
58736-961	587.36 SERIES DUST COVER	
TUBE YOKES		
58736-26761	587.36 SERIES 100MM TUBE	
10883	587.36 SERIES 100 X 6.00 TUBE - DOUBLE CARDAN APPLICATION	
CENTRE YOKES		
13201	587.36 SERIES CENTRE YOKE	
CENTRE BEARINGS		
CB-60200	587.36 SERIES 60MM X 36.6MM BRG, BHC = 200MM	SLOTTED
CB-60200-1	587.36 SERIES 60MM X 36.6MM BRG, BHC = 200MM	SOLID
SHORT COUPLE SETS		
58736-03-390	587.36 SERIES SHORT COUPLED, LZ = 390MM CLOSED C-C	
58736-03-430	587.36 SERIES SHORT COUPLED, LZ = 430MM CLOSED	
DOUBLE CARDAN PARTS		
58736-556	587.36 SERIES CENTRING BALL	

587.42 SERIES - 57.00 X 152.00 MM

COMPANION FLANGES

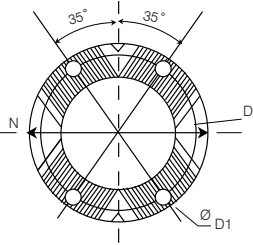

FLANGE YOKES

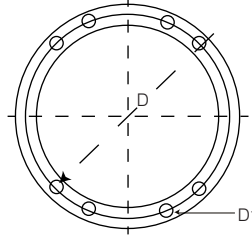
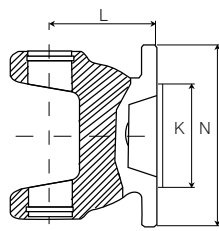

SLIP SETS

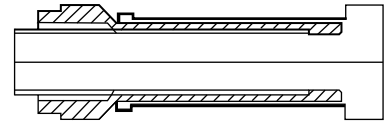

PART NO	ITEM DESCRIPTION	NOTES
UNIVERSAL JOINTS		
U-763	587.42 SERIES 57 X 152	
U-763S	587.42 SERIES 57 X 152	LFL
COMPANION FLANGES		
180KV-1-3491	587.42 SERIES 10SPL ROADRANGER	
180KV-1-6371	587.42 SERIES 39SPL ROCKWELL DIFF	
180KV-1-3201	587.42 SERIES 46SPL ROCKWELL DIFF	
180KV-1-4631	587.42 SERIES 54SPL ROADRANGER	
FLANGE YOKES		
58742-02225	587.42 SERIES - N = 225MM	BLANK
FY58-15	587.42 SERIES 1880 BOLTING - N = 241.30MM, D = 209.60MM, D1 = 15.90MM (X 8), K = 177.80MM	
SLIP SETS		
58742-23756	587.42 SERIES DUST COVER	
58742-856	587.42 SERIES DUST COVER	

587.50 SERIES - 72.00 X 185.00 MM

FLANGE YOKES

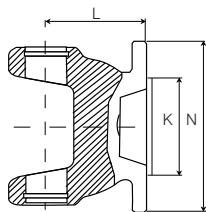
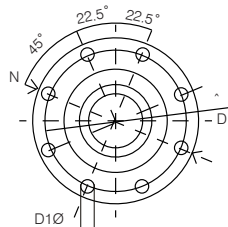

SLIP SETS

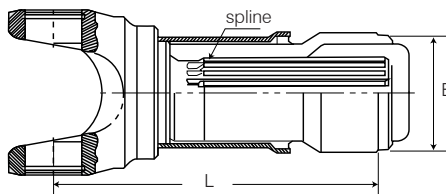

TUBE YOKES

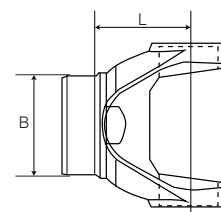

SHORT COUPLE SETS

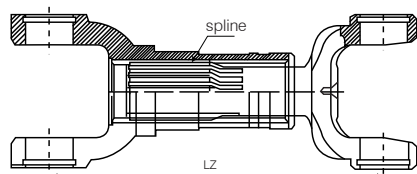

PART NO	ITEM DESCRIPTION	NOTES
UNIVERSAL JOINTS		
K5-A625	587.50 SERIES 72 X 185	
FLANGE YOKES		
58750-02225816	587.50 SERIES - N = 225MM, D = 196.00MM, D1 = M16 (X 8), K = 140.00MM	
SLIP SETS		
58750-6-001	587.50 SERIES SLIP SET	
TUBE YOKES		
58750-26-001	587.50 SERIES 144 X 7MM TUBE	
SHORT COUPLE SETS		
58750-03-505	587.50 SERIES SHORT COUPLED, LZ = 505MM C - C CLOSED	

587.55 SERIES - 74.00 X 217.00 MM

FLANGE YOKES

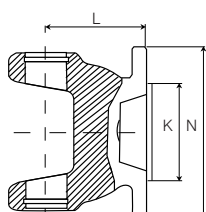
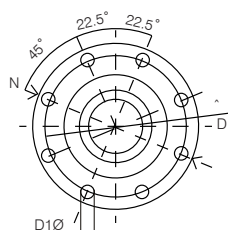

SLIP SETS

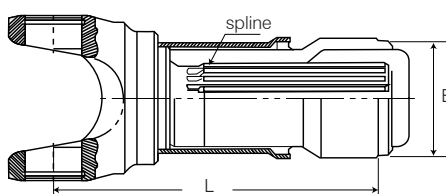

TUBE YOKES

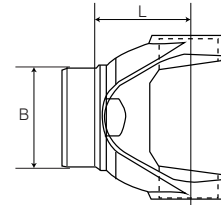

PART NO	ITEM DESCRIPTION	NOTES
UNIVERSAL JOINTS		
K5-A708	587.55 SERIES 74 X 217	4 POINT LUBE

587.55 SERIES - 74.00 X 217.00 MM

PART NO	ITEM DESCRIPTION	NOTES
FLANGE YOKES		
58755-02225816	587.55 SERIES - N = 225MM, D = 196.00MM, D1 = M16 (X 8), K = 140.00MM	
58755-02250818	587.55 SERIES - N = 250MM, D = 218.00MM, D1 = M18 (X 8), K = 140.00MM	
SLIP SETS		
58755-6-001	587.55 SERIES SLIP SET, L = 435MM	
58755-342C	587.55 SERIES SPLINE SET SEMI-FINISHED	
TUBE YOKES		
58755-26-001	587.55 SERIES 165MM TUBE	
58755-26-002	587.55 SERIES 170MM TUBE	

687.15 SERIES - 27.00 X 74.50 MM

FLANGE YOKES

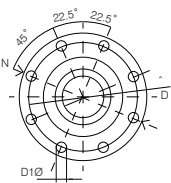

SLIP SETS

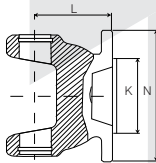

TUBE YOKES

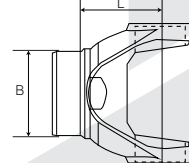
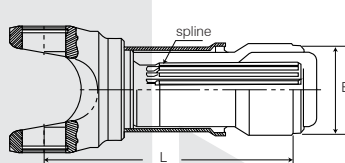

SHORT COUPLE SETS

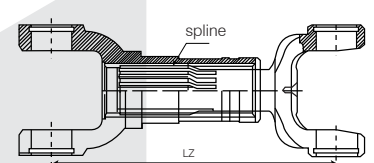

PART NO	ITEM DESCRIPTION	NOTES
UNIVERSAL JOINTS		
K5-A727	687.15 SERIES 27 X 74.5	
K5-A727SP	687.15 SERIES 27 X 74.5	LFL
FLANGE YOKES		
68715-021140	687.15 SERIES 1140 BOLTING - N = 87.30MM, D = 69.85MM, D1 = 7.92MM, K = 57.15MM	
68715-2-1300	687.15 SERIES 1300 BOLTING - N = 96.80MM, D = 79.37MM, D1 = 9.53MM, K = 60.33MM	
68715-2-1410	687.15 SERIES 1410 BOLTING - N = 116.00MM, D = 95.25MM, D1 = 11.11MM, K = 69.85MM	
68715-2-10068	687.15 SERIES 100DIN - N = 100.00MM, D = 84.00MM, D1 = M8 (X 6), K = 57.00MM	
68715-2-120808	687.15 SERIES 120DIN - N = 120.00MM, D = 101.50MM, D1 = M8 (X 8), K = 75.00MM	
SLIP SETS		
68715-6-001	687.15 SERIES SLIP SET - L = 175MM	
68715-6-002	687.15 SERIES SLIP SET - L = 230MM	
68715-382002	687.15 SERIES SLIP SET - L = 205MM	

687.15 SERIES - 27.00 X 74.50 MM

PART NO	ITEM DESCRIPTION	NOTES
TUBE YOKES		
68715-26-001	687.15 SERIES - 2.50 x .095	
68715-26-004	687.15 SERIES - 52 X 3.5	
SHORT COUPLE SETS		
68715-03-185	687.15 SERIES SHORT COUPLED, LZ = 185MM C-C	

687.20 SERIES - 30.20 X 81.80 MM

FLANGE YOKES

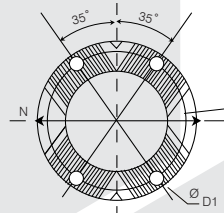
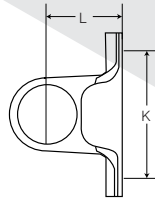
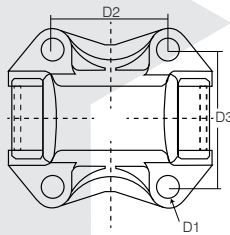
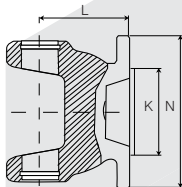
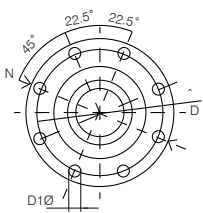

TUBE YOKES

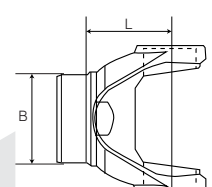

SLIP SETS

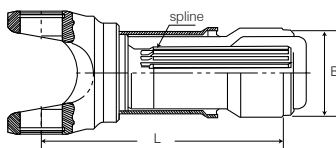

CENTRE YOKES

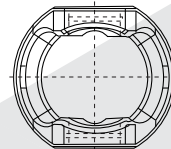
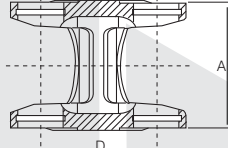

SHORT COUPLE SETS

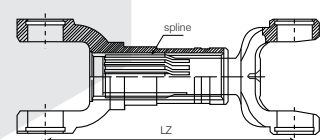

PART NO	ITEM DESCRIPTION	NOTES
UNIVERSAL JOINTS		
802038	687.20 SERIES 30.2 X 81.8	
802038S	687.20 SERIES 30.2 X 81.8	LFL
FLANGE YOKES		
68720-02100	687.20 SERIES 100DIN - N = 100MM	BLANK
68720-0210068	68720 SERIES 100DIN - N = 100MM, D = 84.00MM, D1 = M8 (X 6), K = 57.00MM	
68720-02120	68720 SERIES 120DIN - N = 120MM	BLANK
68720-02120411	687.20 SERIES 120KV - N = 120MM, D = 100.00MM, D1 = 11.00 (X 4), L = 60MM	
68720-02120810	687.20 SERIES - N = 120MM, D = 101.50MM, D1 = M10 (X 8), K = 75.00MM, L = 57MM	
68720-0212088	687.20 SERIES - N = 120MM, D = 101.50MM, D1 = M8 (X 8), K = 75.00MM	
68720-021310	687.20 SERIES 1310 BOLTING - N = 96.80MM, D = 79.37MM, D1 = 9.53MM, K = 60.33MM	
68720-02001-50	687.20 SERIES 1410 BOLTING - D2 = 61.20MM, D3 = 72.90MM, K = 69.85MM, L = 48MM	ROUND
68720-020040	687.20 SERIES TOYOTA BOLTING - D2 = 60.00MM, D3 = 60.00MM, K = 46.00MM	

687.20 SERIES - 30.20 X 81.80 MM

PART NO	ITEM DESCRIPTION	NOTES
FLANGE YOKES		
68720-02097	687.20 SERIES SPRINTER - N = 132MM, D = 112.00MM, D1 = 10MM (X 4), K = 67.00MM	
68720-02130	687.20 SERIES SPRINTER - N = 132MM, K = 67.00MM	BLANK
68720-02146B	687.20 SERIES SPRINTER - N = 146MM, K = 67.00MM	BLANK
SLIP SETS		
68720-6-001	687.20 SERIES SLIP SET 3.00 X .095 TUBE, L = 220MM	
68720-6-002	687.20 SERIES SLIP SET 2.50 TUBE, L = 220MM	
TUBE YOKES		
68720-26-001	687.20 SERIES - 3.00 TUBE	
68720-26-002	687.20 SERIES - 2.50 TUBE	
CENTRE YOKES		
68720-0199	687.20 SERIES C - C = 70MM	
SHORT COUPLE SETS		
68720-03-209	687.20 SERIES SHORT COUPLED LZ = 209MM C - C	
68720-03-295	687.20 SERIES SHORT COUPLED LZ = 295MM C - C	

687.25 SERIES - 34.90 X 92.00 MM

FLANGE YOKES

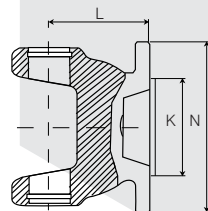
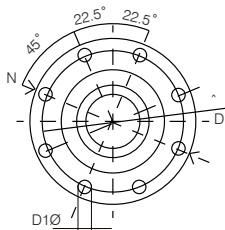

SLIP SETS

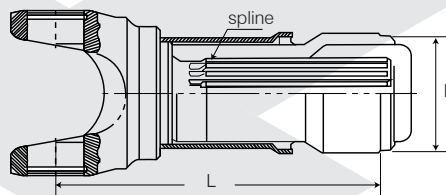

TUBE YOKES

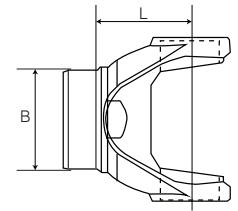

PART NO	ITEM DESCRIPTION	NOTES
UNIVERSAL JOINTS		
K5-A729	687.25 SERIES 34.9 X 92	
K5-A729SP	687.25 SERIES 34.9 X 92	LFL
FLANGE YOKES		
68725-02120810	687.25 SERIES - N = 120MM, D = 101.50MM, D1 = M10 (X 8), K = 75.00MM, L = 70MM	
68725-02120411	687.25 SERIES 120KV - N = 120MM, D = 100.00MM, D1 = 11.00 (X 4), L = 60MM	
68725-02150812	687.25 SERIES - N = 150MM, D = 130.00MM, D1 = M12 (X 8), K = 90.00MM, L = 60MM	
SLIP SETS		
68725-6-3	687.25 SERIES SLIP SET - 3.50 TUBE, L = 232MM	
68725-6-001	687.25 SERIES SLIP SET - 3.50 TUBE, L = 281MM	

687.25 SERIES - 34.90 X 92.00 MM

PART NO	ITEM DESCRIPTION	NOTES
TUBE YOKE		
68725-26-001	687.25 SERIES - 3.50 X .095	
SMALL PARTS		
2025-0708	687.25 SERIES CIRCLIPS 34.9 X 1.725	

687.30 SERIES - 34.93 X 106.38 MM

FLANGE YOKES

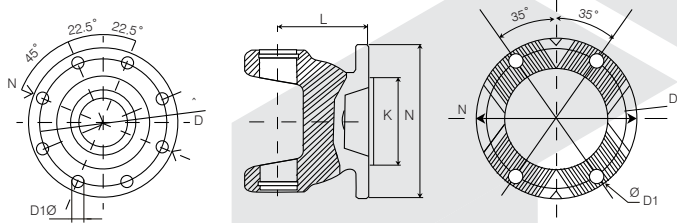

SLIP SETS

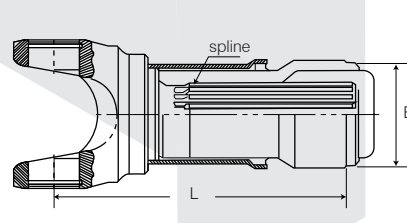

TUBE YOKES

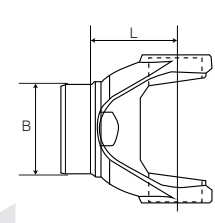

MIDSHIP C/BEARING ASSEMBLY

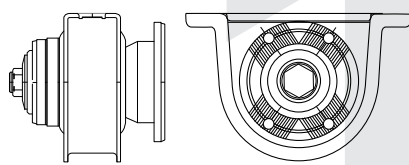

SHORT COUPLE SETS

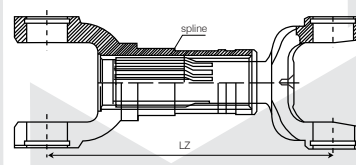

PART NO	ITEM DESCRIPTION	NOTES
UNIVERSAL JOINTS		
K5-A730	687.30 SERIES 34.93 X 106.38	
K5-A730S	687.30 SERIES 34.93 X 106.38	LFL
FLANGE YOKES		
68730-02-120B	687.30 SERIES - N = 120MM	BLANK
68730-02120810	687.30 SERIES - N = 120MM, D = 101.50MM, D1 = M10 (X 8), K = 75.00MM, L = 72MM	
68730-02120411	687.30 SERIES 120KV - N = 120MM, D = 100.00MM, D1 = 11.00 (X 4), L = 64MM	
68730-02150B	687.30 SERIES - N = 150MM	BLANK
68730-02150812	687.30 SERIES - N = 150MM, D = 130.00MM, D1 = M12 (X 8), K = 90.00MM, L = 70MM	
68730-02150413	687.30 SERIES 150KV - N = 150MM, D = 130.00MM, D1 = 13.00 (X 4),	
68730-021500	687.30 SERIES 1510 BOLTING - N = 146.00MM, D = 120.65MM, D1 = 12.70MM, K = 95.20MM	
SLIP SETS		
68730-6-002	687.30 SERIES SLIP SET 3.00 TUBE, L = 225MM	
68730-6-001	687.30 SERIES SLIP SET 3.50 TUBE, L = 255MM	
68730-195	687.30 SERIES DUST COVER	

687.30 SERIES - 34.93 X 106.38 MM

PART NO	ITEM DESCRIPTION	NOTES
TUBE YOKES		
68730-26-002	687.30 SERIES - 3.00 TUBE	
68730-26-001	687.30 SERIES - 3.50 TUBE	
CENTRE BEARINGS		
211447X	687.30 SERIES 45MM X 19MM BRG, BHC = 194MM	45MM CARGO
MIDSHIP C/BEARING ASSEMBLIES		
68730-8-120411	687.30 SERIES HANGER BRG SET 120KV - 45MM BEARING	
SHORT COUPLE SETS		
68730-03-253	687.30 SERIES SHORT COUPLED, LZ = 253MM CLOSED	
68730-03-335	687.30 SERIES SHORT COUPLED, LZ = 335MM CLOSED	
DOUBLE CARDAN PARTS		
68730-150DC	687.30 SERIES DOUBLE CARDAN ASSEMBLY, 150 DIN FLANGES	

687.35 SERIES - 42.00 X 119.40 MM

FLANGE YOKES

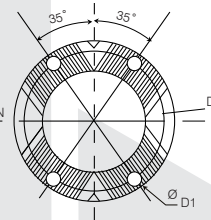
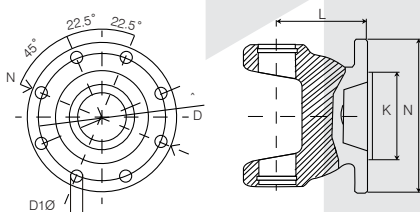

SLIP SETS

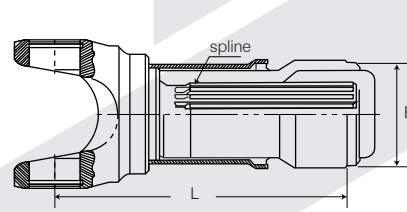

TUBE YOKES

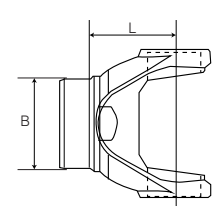

SHORT COUPLE SETS

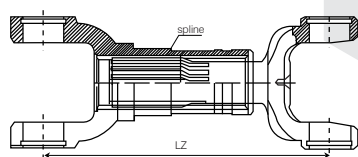

PART NO	ITEM DESCRIPTION	NOTES
UNIVERSAL JOINTS		
802054	687.35 SERIES 42 X 119.4	
802054S	687.35 SERIES 42 X 119.4	LFL
FLANGE YOKES		
68735-02120411	687.35 SERIES 120KV - N = 120MM, D = 100.00MM, D1 = 11.00 (X 4), L = 71MM	
68735-02150B	687.35 SERIES - N = 150MM, L = 72MM	BLANK
68735-02150812	687.35 SERIES - N = 150MM, D = 130.00MM, D1 = M12 (X 8), K = 90.00MM, L = 72MM	
68735-02150413	687.35 SERIES 150KV - N = 150MM, D = 130.00MM, D1 = 13.00 (X 4), L = 80MM	
68735-02180B	687.35 SERIES - N = 180MM, L = 90MM	BLANK
68735-02180814	687.35 SERIES - N = 180.00MM, D = 155.50MM, D1 = M14 (X 8), L = 90MM	

687.35 SERIES - 42.00 X 119.40 MM

PART NO	ITEM DESCRIPTION	NOTES
FLANGE YOKES		
68735-021500	687.35 SERIES 1510 BOLTING - N = 146.00MM, D = 120.65MM, D1 = 12.70MM, K = 95.20MM	
68735-02001	687.35 SERIES 1610 BOLTING - N = 175.00MM, D = 155.60MM, D1 = 9.50MM (X 8), K = 168.30MM	
SLIP SETS		
68735-6-001	687.35 SERIES SLIP SET 100 X 3 TUBE, L = 285MM	
TUBE YOKE		
68735-26-001	687.35 SERIES - 100MM TUBE	
CENTRE BEARINGS		
211447X	687.35 SERIES 45MM X 19MM BRG, BHC = 194MM	45MM CARGO
SHORT COUPLE SETS		
68735-03-318	687.35 SERIES SHORT COUPLED - LZ = 318MM	

687.40 SERIES - 47.63 X 135.17 MM

FLANGE YOKES

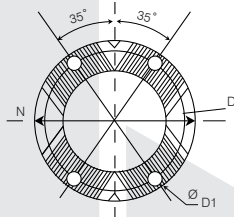
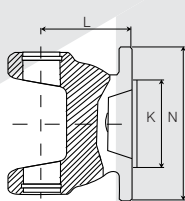
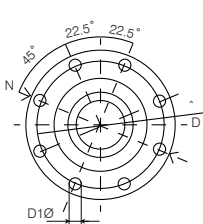

SLIP SETS

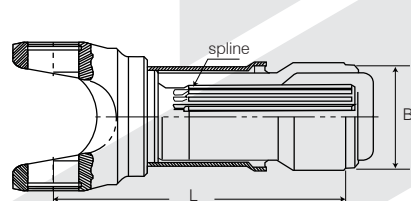

TUBE YOKES

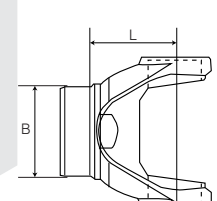

MIDSHIP C/BEARING ASSEMBLY

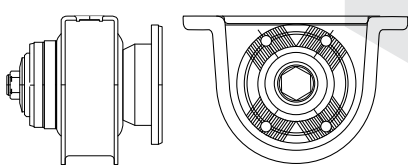

DRIVESHAFTS / SHORT COUPLE SETS

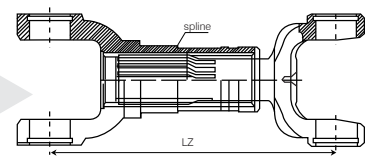
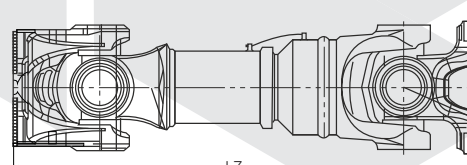

PART NO	ITEM DESCRIPTION	NOTES
UNIVERSAL JOINTS		
802043	687.40 SERIES 47.63 X 135.17	
802043S	687.40 SERIES 47.63 X 135.17	LFL
FLANGE YOKES		
68740-02150	687.40 SERIES - N = 150.00MM	BLANK
68740-02150812	687.40 SERIES - N = 150.00MM, D = 130.00MM, D1 = M12 (X 8), K = 90.00MM, L = 100.00MM	
68740-02150413	687.40 SERIES 150KV - N = 150.00MM, D = 130.00MM, D1 = 13.00 (X 4), L = 80.00MM	
68740-02150413WA	687.40 SERIES 150KV - N = 150.00MM, D = 130.00MM, D1 = 13.00 (X 4), L = 102.00MM	WIDE ANGLE
68740-02165816	687.40 SERIES - N = 165.00MM, D = 140.00, D1 = M16 (X 8), K = 95.00MM	
68740-02180814	687.40 SERIES - N = 180.00MM, D = 155.50MM, D1 = M14 (X 8), L = 95.00MM	

687.40 SERIES - 47.63 X 135.17 MM

PART NO	ITEM DESCRIPTION	NOTES
FLANGE YOKES		
68740-02002	687.40 SERIES 180KV - N = 180MM, D = 150.00MM, D1 = M15 (X 4), L = 100MM	WIDE ANGLE
68740-02003WA	687.40 SERIES 1600 BOLTING - N = 174.50MM, D = 155.50MM, D1 = 9.53MM (X 8), K = 168.25MM	
68740-021800	687.40 SERIES 1810 BOLTING - N = 203.00MM, D = 184.20MM, D1 = 11.13MM (X 12), K = 196.90MM	
SLIP SETS		
68740-6-001	687.40 SERIES SLIP SET, L = 250MM	
68740-6-002	687.40 SERIES SLIP SET LONG, L = 335MM	
68740-23132	687.40 SERIES DUST COVER	
TUBE YOKE		
68740-26-001	687.40 SERIES - 120MM TUBE	
68740-26-002	687.40 SERIES - 100MM X 4.5 TUBE, WIDE ANGLE	
CENTRE BEARINGS		
CB-55194	687.40 SERIES 55MM X 18MM BRG, BHC= 194MM	55MM CARGO
MIDSHIP C/BEARING ASSEMBLIES		
68740-454-150KV	687.40 SERIES 150 KV MIDSHIP ASSEMBLY (BEARING NOT INCLUDED)	
68740-6454	687.40 SERIES SLIDING MIDSHIP ASSEMBLY (BEARING NOT INCLUDED)	
DRIVESHAFTS & SHORT COUPLE SETS		
68740-03-265	687.40 SERIES SHORT COUPLED, LZ = 265MM CLOSED	
68740-03-311	687.40 SERIES SHORT COUPLED, LZ = 302MM CLOSED	
8740-03-370	687.40 SERIES SHORT COUPLED, LZ = 335MM CLOSED	

687.45 SERIES - 52.00 X 147.20 MM

FLANGE YOKES

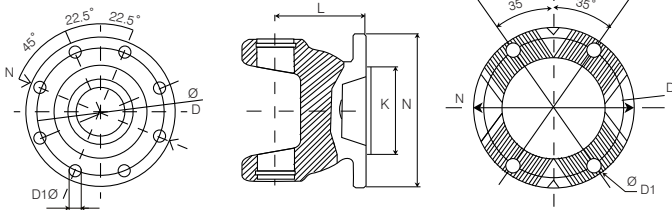

SLIP SETS

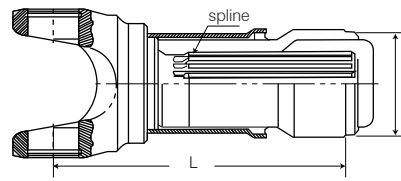

TUBE YOKES

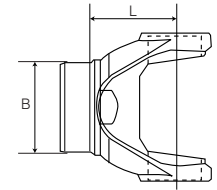

MIDSHIP C/BEARING ASSEMBLY

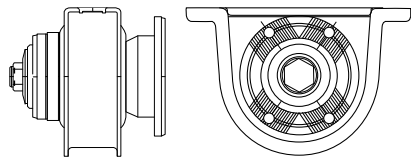

DRIVESHAFTS / SHORT COUPLE SETS

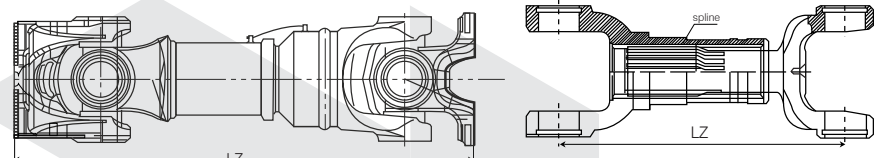

PART NO	ITEM DESCRIPTION	NOTES
UNIVERSAL JOINTS		
802029	687.45 SERIES 52 X 147.2	
802029S	687.45 SERIES 52 X 147.2	LFL
FLANGE YOKES		
68745-02180415	687.45 SERIES 180KV - N = 180MM, D = 150.00MM, D1 = M15 (X 4), L = 97MM	
68745-02180814	687.45 SERIES - N = 180.00MM, D = 155.50MM, D1 = M14 (X 8), K = 110.00MM, L = 95MM	
68745-02180415WA	687.45 SERIES 180KV - N = 180MM, D = 150.00MM, D1 = M15 (X 4), L = 108MM	W/A
68745-02225B	687.45 SERIES - N = 225.00MM, K = 140.00MM	BLANK
68745-02225816WA	687.45 SERIES - N = 225.00MM, D = 196.00, D1 = M16 (X 8), K = 140.00MM	W/A
68745-021810	687.45 SERIES 1810 BOLTING - N = 203.00MM, D = 184.20MM, D1 = 11.13MM (X 12), K = 196.90MM	
SLIP SETS		
68745-6-001	687.45 SERIES SLIP SET, L = 265MM	
68745-6-002	687.45 SERIES SLIP SET - LONG, L = 355MM	
68745-6-002G	687.45 SERIES SLIP SET - LONG, L = 355MM - GREASABLE	
TUBE YOKES		
68745-26-001	687.45 SERIES - 120MM TUBE	
68745-26-002	687.45 SERIES - 110MM TUBE	W/A
CENTRE BEARINGS		
210661-1X	687.45 SERIES 60MM BRG - BHC = 219.1MM	SLOTTED
210661-1XSA	687.45 SERIES 60MM BRG - BHC = 219.1MM, SELF ALIGNING	SLOTTED
210875-1X	687.45 SERIES 60MM BRG - BHC = 219.1MM	SOLID
210875-1XSA	687.45 SERIES 60MM BRG - BHC = 219.1MM, SELF ALIGNING	SOLID
MIDSHIP C/BEARING ASSEMBLIES		
18057-6036120L	180KV MIDSHIP ASSY, 60 X 36 BRG, 120MM TUBE (BEARING NOT INCLUDED)	
DRIVESHAFTS & SHORT COUPLE SETS		
68745-03-684	687.45 SERIES I/A SHAFT 180KV, LZ = 684MM	
68745-03-317	687.45 SERIES SHORT COUPLED, LZ = 311MM C-C CLOSED	
68745-03-430	687.45 SERIES SHORT COUPLED, LZ = 430MM C-C CLOSED	

687.55 SERIES - 57.00 X 152.00 MM

FLANGE YOKES

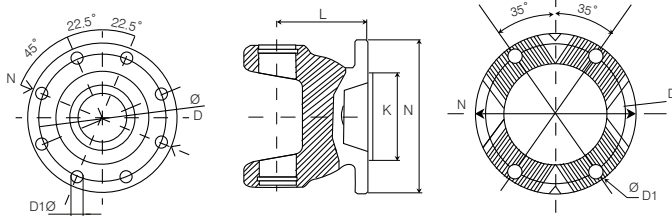

SLIP SETS

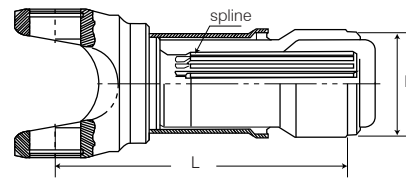

TUBE YOKES

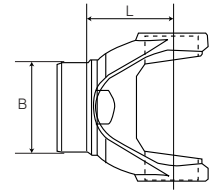

MIDSHIP C/BEARING ASSEMBLY

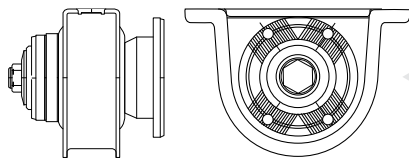

DRIVESHAFTS / SHORT COUPLE SETS

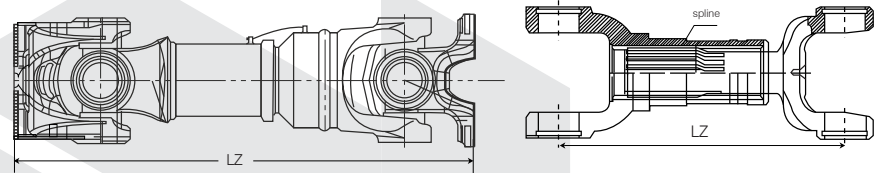

PART NO	ITEM DESCRIPTION	NOTES
UNIVERSAL JOINTS		
U-763	687.55 SERIES 57 X 152	
U-763S	687.55 SERIES 57 X 152	LFL
FLANGE YOKES		
68755-02180B	687.55 SERIES - N = 180.00MM	BLANK
68755-02180814	687.55 SERIES - N = 180.00MM, D = 155.50MM, D1 = M14 (X 8), K = 110.00MM	
68755-021801016	687.55 SERIES - N = 180.00MM, D = 155.50MM, D1 = M16 (X 10), K = 110.00MM	
68755-02180415	687.55 SERIES 180KV - N = 180.00MM, D = 150.00MM, D1 = M15 (X 4), L = 90MM	
68755-0218041535	687.55 SERIES - N = 180.00MM, D = 150.00MM, D1 = M15 (X 4), L = 100MM	W/A 35 DEG.
68755-02225	687.55 SERIES - N = 225.00MM	BLANK
68755-02225816	687.55 SERIES - N = 225.00MM, D = 196.00MM, D1 = M16 (X 8), K = 140.00MM	
68755-022251016	687.55 SERIES - N = 225.00MM, D = 196.00MM, D1 = M16 (X 10), K = 140.00MM	
68755-021810	687.55 SERIES 1810 BOLTING - N = 203.00MM, D = 184.20MM, D1 = 11.13MM (X 12), K = 196.90MM	
68755-021810SC	687.55 SERIES 1810 BOLTING - N = 203.00MM, D = 184.20MM, D1 = 11.13MM (X 12), K = 196.90MM	S/COUPLE
SLIP SETS		
68755-6-001	687.55 SERIES SLIP SET - L = 295MM, 120MM TUBE	
68755-6-002	687.55 SERIES SLIP SET - L = 405MM, 100MM TUBE	
TUBE YOKES		
68755-26-001	687.55 SERIES - 120MM TUBE	
68755-26-002	687.55 SERIES - 110MM TUBE	
CENTRE BEARINGS		
210661-1X	687.55 SERIES 60MM BRG - BHC = 219.1MM	SLOTTED
210661-1XSA	687.55 SERIES 60MM BRG - BHC = 219.1MM, SELF ALIGNING	SLOTTED
210875-1X	687.55 SERIES 60MM BRG - BHC = 219.1MM	SOLID
210875-1XSA	687.55 SERIES 60MM BRG - BHC = 219.1MM, SELF ALIGNING	SOLID
MIDSHIP C/BEARING ASSEMBLIES		
18057-6036120L	180KV MIDSHIP ASSY, 60 X 36 BRG, 120MM TUBE (BEARING NOT INCLUDED)	

687.55 SERIES - 57.00 X 152.00 MM

PART NO	ITEM DESCRIPTION	NOTES
SHORT COUPLE SETS		
68755-03-230	687.55 SERIES SHORT COUPLED, LZ = 230MM C - C CLOSED	
68755-03-333	687.55 SERIES SHORT COUPLED, LZ = 333MM C - C CLOSED	
68755-03-405	687.55 SERIES SHORT COUPLED, LZ = 405MM C - C CLOSED	
68755-03-470	687.55 SERIES SHORT COUPLED, LZ = 470MM C - C CLOSED	
SMALL PARTS		
2055-0703	687.55 SERIES CIRCLIP 57 X 2.35MM	

687.60 SERIES - 59.00 X 167.60 MM

FLANGE YOKES

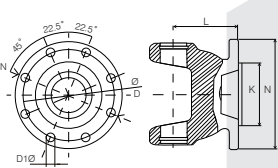

SLIP SETS

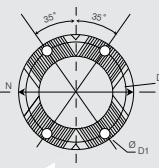

TUBE YOKES

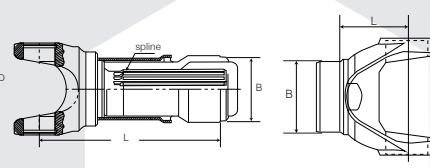

MIDSHIP C/BEARING ASSEMBLY

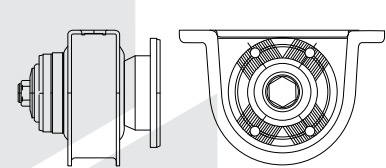

PART NO	ITEM DESCRIPTION	NOTES
UNIVERSAL JOINTS		
802041	687.60 SERIES 59 X 167.60	
802041S	687.60 SERIES 59 X 167.60	LFL
FLANGE YOKES		
68760-021801016	687.60 SERIES - N = 180.00MM, D = 155.50MM, D1 = M16 (X 10), K = 110.00MM	
68760-02180415	687.60 SERIES 180KV - N = 180.00MM, D = 150.00MM, D1 = M15 (X 4), L = 100MM	
68760-021800	687.60 SERIES 1810 BOLTING - N = 203.00MM, D = 184.20MM, D1 = 11.13MM (X 12), K = 196.90MM	
SLIP SETS		
68760-6-001	687.60 SERIES SLIP SET - L = 300MM, 130MM TUBE	
68760-402	687.60 SERIES DUST SHEILD	
TUBE YOKES		
68760-26-001	687.60 SERIES - 130MM TUBE	
CENTRE BEARINGS		
CB-70219	687.60 SERIES 70MM BRG - BHC = 219.1MM	SLOTTED
CB-70219-1	687.60 SERIES 70MM BRG - BHC = 219.1MM	SOLID
MIDSHIP C/BEARING ASSEMBLIES		
18057-7045130L	180KV MIDSHIP ASSY, 70 X 45 BRG, 130MM TUBE (BEARING NOT INCLUDED)	
SMALL PARTS		
2060-0703	687.60 SERIES CIRCLIP 59 X 2.15MM	

687.65 SERIES - 65.00 X 172.00 MM

FLANGE YOKES

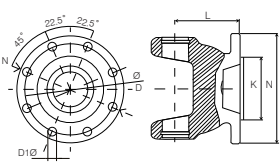

SLIP SETS

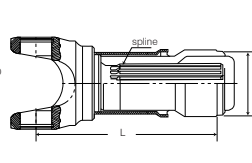
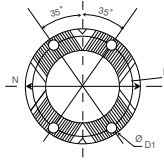

TUBE YOKES

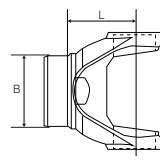

MIDSHIP C/BEARING ASSEMBLY

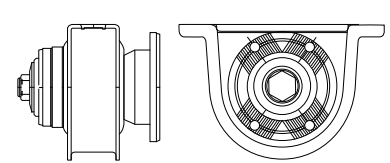

PART NO	ITEM DESCRIPTION	NOTES
UNIVERSAL JOINTS		
K5-A643	687.65 SERIES 65 X 172	
K5-A643S	687.65 SERIES 65 X 172	LFL
FLANGE YOKES		
68765-02180415	687.65 SERIES 180KV - N = 180.00MM, D = 150.00MM, D1 = M15 (X 4)	
68765-02225816	687.65 SERIES - N = 225.00MM, D = 196.00MM, D1 = M16 (X 8), K = 140.00MM	
68765-02250	687.65 SERIES - N = 250.00MM	BLANK
SLIP SETS		
68765-6-001	687.65 SERIES SLIP SET - L = 305MM, 140MM TUBE	
68765-6-002	687.65 SERIES SLIP SET - L = 415MM, 140MM TUBE	
68765-6-003	687.65 SERIES SLIP SET - L = 335MM, 120 X 6MM TUBE	
TUBE YOKES		
68765-26-002	687.65 SERIES - 120MM TUBE	
68765-26-001	687.65 SERIES - 140MM TUBE	
CENTRE BEARINGS		
CB-70219	687.65 SERIES 70MM BRG - BHC = 219.1MM	SLOTTED
CB-70219-1	687.65 SERIES 70MM BRG - BHC = 219.1MM	SOLID
MIDSHIP C/BEARING ASSEMBLIES		
18057-7045140L	180KV MIDSHIP ASSY, 70 X 45 BRG, 140MM TUBE (BEARING NOT INCLUDED)	
SMALL PARTS		
2065-0701	687.65 SERIES CIRCLIP 65 X 2.5MM	
2065-0702	687.65 SERIES CIRCLIP 65 X 2.7MM	

FODEN

PART NO	ITEM DESCRIPTION	NOTES
STEERING SHAFTS		
1006	FODEN STEERING SHAFT - 1.00 X 79 SPL, L = 176.00MM C - C CLOSED	

MERCEDES

286.22 SERIES - 42.00 X 106.00 MM

FLANGE YOKES

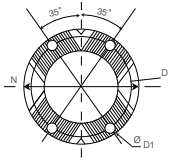

SLIP SETS

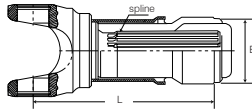

TUBE YOKES

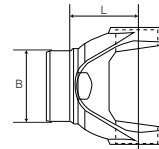

PART NO	ITEM DESCRIPTION	NOTES
UNIVERSAL JOINTS		
802057	MERCEDES 286.22 SERIES 42 X 106	
802057S	MERCEDES 286.22 SERIES 42 X 106	LFL
FLANGE YOKES		
28622-02120411	MERCEDES 286.22 SERIES 120KV - N = 120MM, D = 100.00MM, D1 = 11.00 (X 4)	
SLIP SETS		
28622-6-001	MERCEDES 286.22 SERIES SLIP SET - L = 280MM, 90MM TUBE	
TUBE YOKES		
28622-26-001	MERCEDES 286.22 SERIES - 90MM TUBE	

MERCEDES

385.00 SERIES - 48.00 X 126.00 MM

FLANGE YOKES

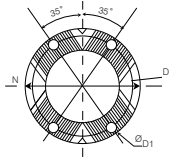

SLIP SETS

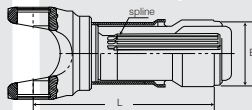

TUBE YOKES

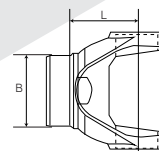

PART NO	ITEM DESCRIPTION	NOTES
UNIVERSAL JOINTS		
U-765	MERCEDES 385.00 SERIES 48 X 126	
U-765S	MERCEDES 385.00 SERIES 48 X 126	LFL
FLANGE YOKES		
0-158-02-150812	MERCEDES 385.00 SERIES - N = 150MM, D = 130.00MM, D1 = M12 (X 8), K = 90.00MM	
0-158-024M13	MERCEDES 385.00 SERIES 150KV - N = 150MM, D = 130.00MM, D1 = 13.00MM (X 4)	
SLIP SETS		
158-6-150812	MERCEDES 385.00 SERIES SLIP SET - L = 400MM INCL FL, 90MM TUBE	
158-6-001	MERCEDES 385.00 SERIES SLIP SET - L = 327MM, 90MM TUBE	
TUBE YOKES		
158-26-001	MERCEDES 385.00 SERIES - 90MM TUBE	
DOUBLE CARDAN PARTS		
0-158-358-051	MERCEDES 385.00 SERIES DOUBLE CARDAN ASSY, 150KV	

MERCEDES 186.37 SERIES - 53.00 X 135.00 MM

FLANGE YOKES

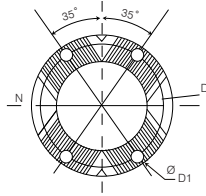
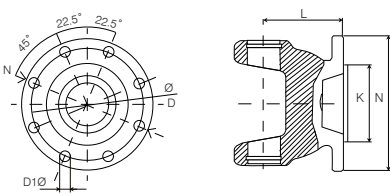

SLIP SETS

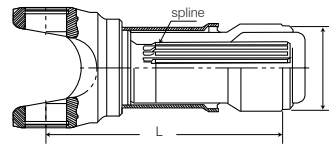

TUBE YOKES

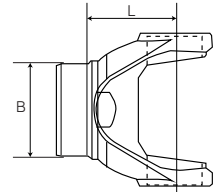

PART NO	ITEM DESCRIPTION	NOTES
UNIVERSAL JOINTS		
U-761	MERCEDES 186.37 SERIES 53 X 135	
U-761S	MERCEDES 186.37 SERIES 53 X 135	LFL
FLANGE YOKES		
18637-02760	MERCEDES 186.37 SERIES - N = 165.00MM, D = 140.00MM, D1 = M14 (X 8), K = 95.00MM, L = 90MM	
18637-02165413	MERCEDES 186.37 SERIES 165KV - N = 165.00MM, D = 140.00MM, D1 = 13.00MM (X 4)	
SLIP SETS		
18637-6-001	MERCEDES 186.37 SERIES SLIP SET - L = 325MM, 100MM TUBE	
TUBE YOKES		
18637-26-001	MERCEDES 186.37 SERIES - 100MM TUBE	

MERCEDES 385.60 SERIES - 68.00 X 95.00 MM

COMPANION FLANGES

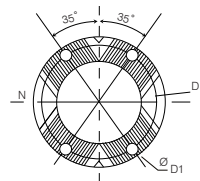

FLANGE YOKES

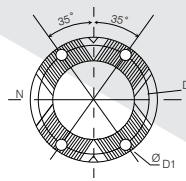

SLIP SETS

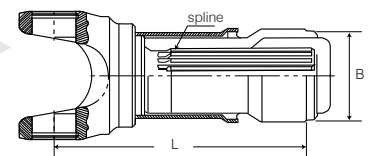

PART NO	ITEM DESCRIPTION	NOTES
UNIVERSAL JOINTS		
801001	MERCEDES 385.60 SERIES 68 X 95 IC	
801001S	MERCEDES 385.60 SERIES 68 X 95 IC	LFL
COMPANION FLANGES		
38560-0118070	MERCEDES 385.60 SERIES 180KV, 4 X 15MM, 70MM C/BEARING	
FLANGE YOKES		
38560-02	MERCEDES 385.60 SERIES 180KV - N = 180.00MM, D = 150.00MM, D1 = M15 (X 4)	
SLIP SETS		
38560-6-001	MERCEDES 385.60 SERIES SLIP SET - L = 400MM, 140MM TUBE	

MERCEDES 385.60 SERIES - 68.00 X 95.00 MM

TUBE YOKES

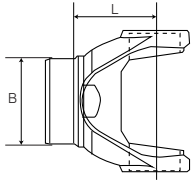

MIDSHIP STUBS

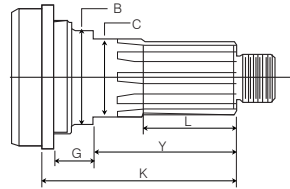

MIDSHIP C/BEARING ASSEMBLY

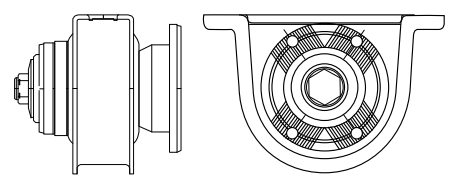

PART NO	ITEM DESCRIPTION	NOTES
TUBE YOKES		
38560-26-001	MERCEDES 385.60 SERIES - 140MM TUBE	
MIDSHIP STUBS		
38560-57001	MERCEDES 385.60 SERIES 140MM TUBE, 70MM C/BEARING	
CENTRE BEARINGS		
CB-70050	MERCEDES 385.60 SERIES 70 X 22 BRG - BHC = 50MM (VERTICAL), 250MM WIDE O/ALL	
CB-70096	MERCEDES 385.60 SERIES 70 X 20 BRG - BHC = 35MM (VERTICAL), 190MM WIDE O/ALL	
CB-70030	MERCEDES 385.60 SERIES 70 X 20 BRG - BHC = 30MM (VERTICAL), 190MM WIDE O/ALL	
MIDSHIP C/BEARING ASSEMBLIES		
38560-454-001	MERCEDES 385.60 SERIES MIDSHIP ASSY, 70MM BRG, 140MM TUBE (BEARING NOT INCLUDED)	

MERCEDES 385.65 SERIES - 68.00 X 117.00 MM

FLANGE YOKES

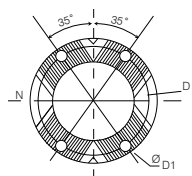

SLIP SETS

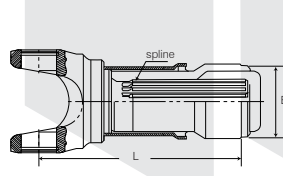

TUBE YOKES

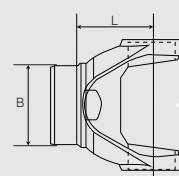

MIDSHIP STUBS

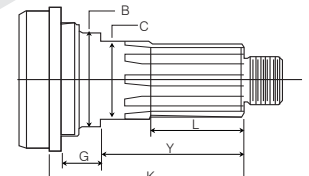

PART NO	ITEM DESCRIPTION	NOTES
UNIVERSAL JOINTS		
K5-A802	MERCEDES 385.65 SERIES 68 X 117 IC	
FLANGE YOKES		
38565-02200	MERCEDES 385.65 SERIES 200KV - N = 200.00MM, D1 = 15.00MM (X 4)	
SLIP SETS		
38565-6-001	MERCEDES 385.65 SERIES SLIP SET - L = 370MM, 144MM TUBE	
TUBE YOKES		
38565-26-001	MERCEDES 385.65 SERIES - 144MM TUBE	
MIDSHIP STUBS		
38565-57001	MERCEDES 385.65 SERIES 144MM TUBE, 80MM C/BEARING	
CENTRE BEARINGS		
CB-80050	MERCEDES 385.65 SERIES 80 X 25 BRG - BHC = 50MM (VERTICAL)	

SCANIA P300 SERIES - 38.00 X 148.00 MM

PART NO	ITEM DESCRIPTION	NOTES
UNIVERSAL JOINTS		
802010	SCANIA P300 (T51) SERIES 38 X 148	4.5 DEG BRKT

SCANIA T60 SERIES - 44.00 X 149.00 MM

SLIP SETS

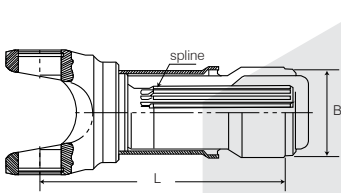

TUBE YOKES

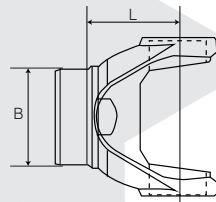

END YOKES

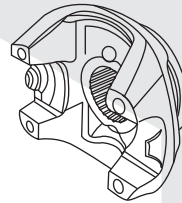

MIDSHIP STUBS

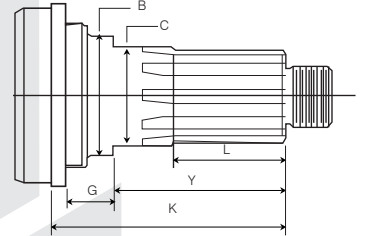

PART NO	ITEM DESCRIPTION	NOTES
UNIVERSAL JOINTS		
U-384	SCANIA T60 SERIES 44 X 149	
SLIP SETS		
T60-342-58720	SCANIA T60 SERIES SLIP SET - L = 320MM, 90MM TUBE	
TUBE YOKES		
SC-26-60	SCANIA T60 SERIES - 90MM TUBE	
END YOKES		
SC169-133	SCANIA T60 SERIES, 54.8MM X 22 SPL	
MIDSHIP STUBS		
SC177-103	SCANIA T60 SERIES 90MM TUBE, 55MM C/BEARING	

SCANIA

P400 SERIES - 48.00 X 161.00 MM

SLIP SETS

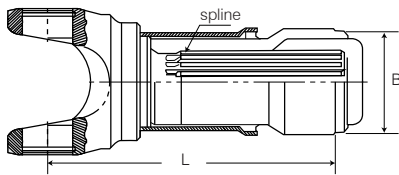

TUBE YOKES

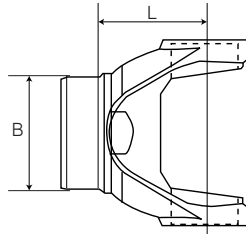

END YOKES

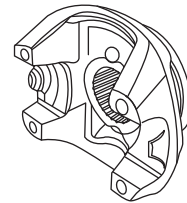

MIDSHIP C/BEARING ASSEMBLY

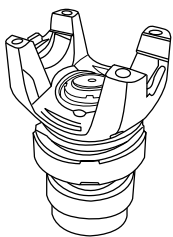

DRIVESHAFTS

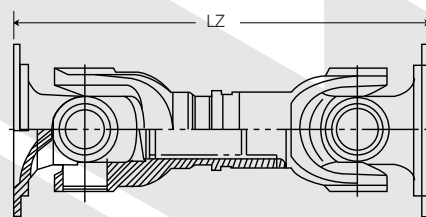

PART NO	ITEM DESCRIPTION	NOTES
UNIVERSAL JOINTS		
802015	SCANIA P400 SERIES 48 X 161 - LESS BRACKET	
802016	SCANIA P400 SERIES 48 X 161 - 4.5 DEGREE TAPER BRACKETS	
802016S	SCANIA P400 SERIES 48 X 161 - 4.5 DEGREE TAPER BRACKETS	LFL
SLIP SETS		
P40-382-95	SCANIA P400 SERIES SLIP SET - L = 340MM, 95MM TUBE	
P400-6-001	SCANIA P400 SERIES MAINSHAFT SLIP SET - L = 300MM, 100MM TUBE	
P400-6-002	SCANIA P400 SERIES INTERAXLE SLIP SET W/A - L = 350MM, 100MM TUBE	
TUBE YOKES		
P400-26-90	SCANIA P400 SERIES - 100MM TUBE	
P400-26-003	SCANIA P400 SERIES WIDE ANGLE - 100MM TUBE	
END YOKE		
SC-4-904	SCANIA P400 SERIES, 54.8MM X 22 SPL - DIFF & GEARBOX	
CENTRE BEARING		
CB-60001	SCANIA P40/50 SERIES - 60MM, 80MM SEAL	
MIDSHIP C/BEARING ASSEMBLIES		
P400-454-001	SCANIA P40 SERIES COMPLETE ASSY	
DRIVESHAFTS		
P400-03-540	SCANIA P40 SERIES INTERAXLE SHAFT - LZ = 540MM C-C CLOSED	
P400-03-600	SCANIA P40 SERIES INTERAXLE SHAFT - LZ = 600MM C-C CLOSED	
SMALL PARTS		
P400-NUT	SCANIA P400/600 SERIES NUT FOR MIDSHIP	
S4365	SCANIA P40/50 SERIES BOLT	

SCANIA

P500 SERIES - 57.00 X 164.00 MM

SLIP SETS

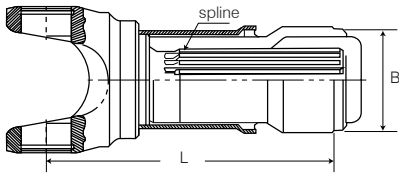

TUBE YOKES

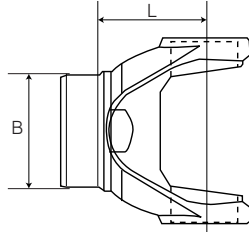

END YOKES

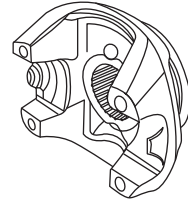

MIDSHIP STUBS

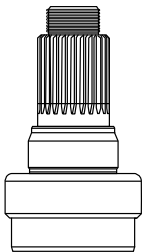

DRIVESHAFTS

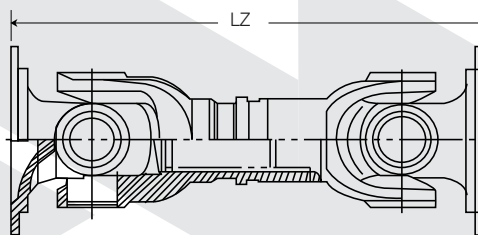

PART NO	ITEM DESCRIPTION	NOTES
UNIVERSAL JOINTS		
802019	SCANIA P50 / P500 SERIES 57 X 164 - 4.5 DEGREE TAPER BRACKETS	
802019S	SCANIA P50 / P500 SERIES 57 X 164 - 4.5 DEGREE TAPER BRACKETS	LFL
SLIP SETS		
P500-6-001	SCANIA P50 / P500 SERIES H/DUTY SLIP SET - L = 304MM, 108MM TUBE	
P500-6-002	SCANIA P500 SERIES WIDE ANGLE SLIP SET - L = 362MM, 90MM TUBE	
TUBE YOKES		
P500-26-001	SCANIA P500 SERIES - 80MM BUTT, WIDE ANGLE	
P500-26-002	SCANIA P500 SERIES - 96.8MM BUTT	
END YOKES		
P500-4-001CB	SCANIA P500 SERIES - CENTRE BEARING, 59.5MM X 24 SPL, (SUITS P500-54-001 STUB)	
SC-4-625	SCANIA P50 SERIES - CENTRE BEARING, 54.8MM X 22 SPL	
SC-4-905	SCANIA P50 SERIES - DIFF & G/BOX, 54.8MM X 22 SPL	
SC-4-P5001IA	SCANIA P50 SERIES, 58.92MM X 24 SPL, SPLINE LENGTH = 85MM, HEIGHT = 132MM	
SC-4-P5002IA	SCANIA P50 SERIES, 54.3MM X 22 SPL, SPLINE LENGTH = 80MM, HEIGHT = 134MM	
SC-4-P5024	SCANIA P50 SERIES - CENTRE BEARING, 59.54MM X 24 SPL	
MIDSHIP STUBS		
P500-54-001	SCANIA P500 SERIES 108MM TUBE, 60MM C/BRG, 24 SPL, L = 155MM (TO SUIT P500-4-001CB YOKE)	
DRIVESHAFTS		
P500-03-530	SCANIA P50 SERIES INTERAXLE - LZ = 530MM C-C CLOSED	
P500-03-570	SCANIA P50 SERIES INTERAXLE - LZ = 570MM C-C CLOSED	

SCANIA

P600 SERIES - 65.00 X 190.00 MM

COMPANION FLANGES

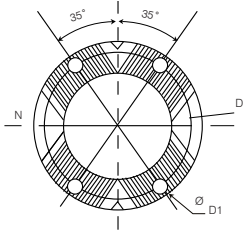

FLANGE YOKES

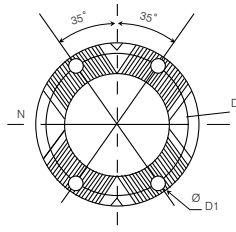

SLIP SETS

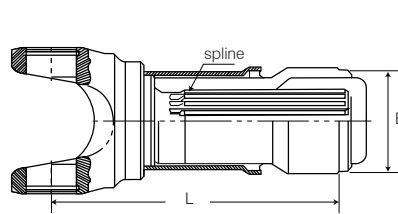

TUBE YOKES

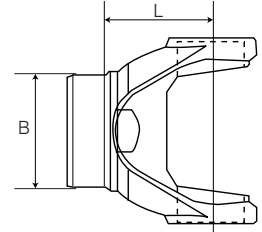

END YOKES

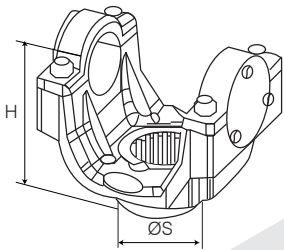

MIDSHIP STUBS

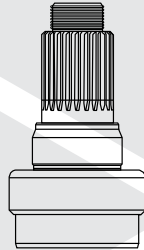

MIDSHIP C/BEARING ASSEMBLY

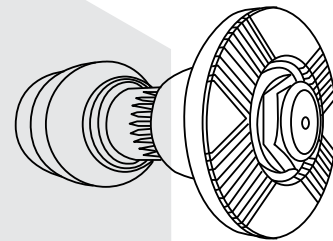

PART NO	ITEM DESCRIPTION	NOTES
UNIVERSAL JOINTS		
802036	SCANIA P600 SERIES 65 X 190	
802036S	SCANIA P600 SERIES 65 X 190	LFL
COMPANION FLANGE		
P600-1-208KV	SCANIA P600 SERIES 208KV, 4 X 15MM, 60MM BRG	
FLANGE YOKES		
P600-2-208KV	SCANIA P600 SERIES 208KV - N = 208.00MM, D = 180.00MM, D1 = 15.00 (X 4)	
SLIP SETS		
P600-6-001	SCANIA P600 SERIES SLIP SET TO SUIT STANDARD WELD - L = 395MM, 114.3MM TUBE	
TUBE YOKES		
P600-26-003	SCANIA P600 SERIES - 114.3 TUBE, 103MM BUTT	
END YOKES		
P600-4-001CB	SCANIA P600 SERIES C/BEARING - 59.54MM X 24 SPL	
MIDSHIP STUBS		
P600-54-001	SCANIA P600 SERIES - 59.54MM X 24 SPL, 60MM C/BRG	
CENTRE BEARINGS		
CB-60002	SCANIA P600 SERIES 60MM, 85MM SEAL	
CB-60003	SCANIA P600 SERIES 60MM, 85MM SEAL, SEALED BEARING	

VOLVO

300 SERIES - 44.00 X 126.20 MM

COMPANION FLANGES

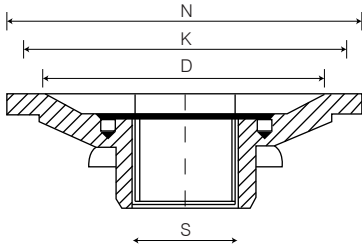

FLANGE YOKES

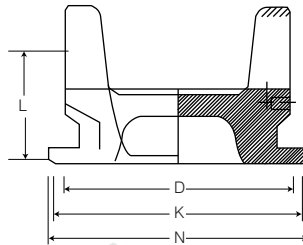

SLIP SETS

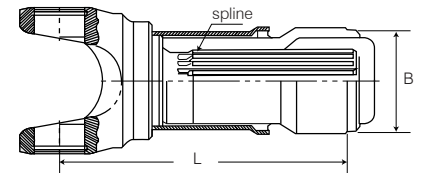

TUBE YOKES



MIDSHIP STUBS

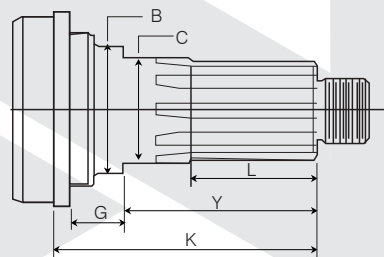

PART NO	ITEM DESCRIPTION	NOTES
UNIVERSAL JOINTS		
U-380	VOLVO 300 SERIES 3 BOLT 44 X 126.2	
COMPANION FLANGES		
V600-1-300	VOLVO 300 SERIES C/BRG 1610 BOLTING (8 HOLE)	
FLANGE YOKES		
VOL-2-300	VOLVO 300 SERIES 1610 FACE - N = 175.00MM, D = 155.60MM, D1 = 9.50MM (X 8), K = 168.30MM	
SLIP SETS		
VOL-6-300	VOLVO 300 SERIES SLIP SET - L = 311MM, 85MM TUBE	
TUBE YOKES		
VOL-28-300	VOLVO 300 SERIES - 85MM TUBE	
MIDSHIP STUBS		
V7057-400	VOLVO 300 / 400 SERIES 60MM X 18 SPL, 60MM BRG	
CENTRE BEARINGS		
CB-60198	VOLVO 300 / 400 SERIES 60MM, BHC = 198MM	

VOLVO

400 SERIES - 50.00 X 152.60 MM

COMPANION FLANGES

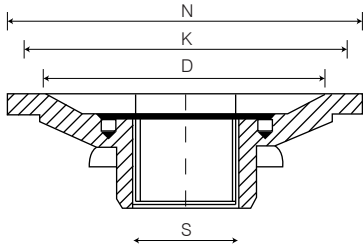

FLANGE YOKES

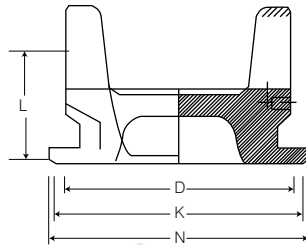

SLIP SETS

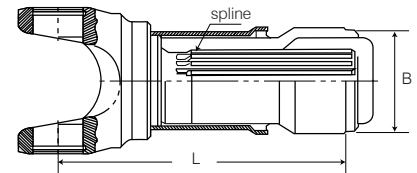

TUBE YOKES



MIDSHIP STUBS

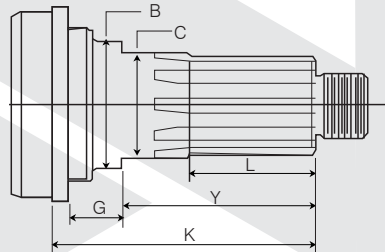

PART NO	ITEM DESCRIPTION	NOTES
UNIVERSAL JOINTS		
U-381	VOLVO 400 SERIES 3 BOLT 50 X 152.60	
COMPANION FLANGES		
V700-1-400	VOLVO 400 SERIES C/BRG 1710 BOLTING (8 HOLE)	
FLANGE YOKES		
VOL-2-400	VOLVO 400 SERIES 1710 FACE - N = 203.00MM, D = 184.20MM, D1 = 9.50MM, K = 196.90MM	
VOL-2-K56	VOLVO 400 SERIES 1610 FACE - N = 175.00MM, D = 155.60MM, D1 = 9.50MM (X 8), K = 168.30MM	
SLIP SETS		
VOL-6-400	VOLVO 400 SERIES SLIP SET - L = 365MM, 91MM TUBE	
TUBE YOKES		
VOL-28-400	VOLVO 400 SERIES - 91MM TUBE	
MIDSHIP STUBS		
V7057-400	VOLVO 400 SERIES 60MM X 18 SPL, 60MM BRG	
CENTRE BEARINGS		
CB-60198	VOLVO 400 SERIES 60MM, BHC = 198MM	

VOLVO

500 SERIES - 57.00 X 152.60 MM

COMPANION FLANGES

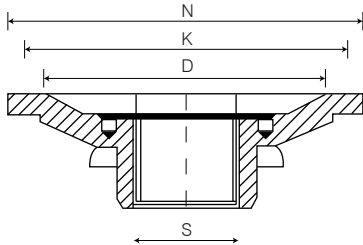

FLANGE YOKES

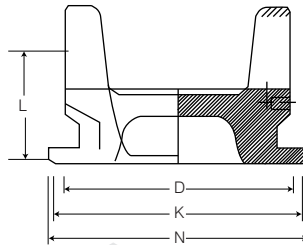

SLIP SETS

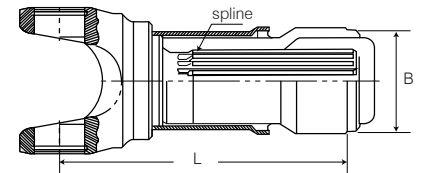

TUBE YOKES



MIDSHIP STUBS

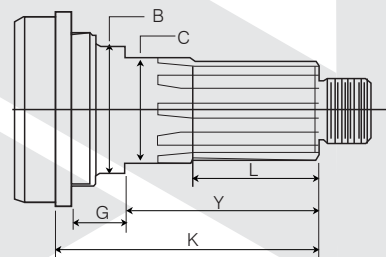

PART NO	ITEM DESCRIPTION	NOTES
UNIVERSAL JOINTS		
803002	VOLVO 500 SERIES 3 BOLT 57 x 152.60	
COMPANION FLANGES		
V800-1-500	VOLVO 500 SERIES C/BRG 1810 BOLTING (12 HOLE)	
FLANGE YOKES		
VOL-2-600	VOLVO 500 SERIES 1810 FACE - N = 203.00MM, D = 184.20MM, D1 = 11.13MM (X 12), K = 196.90MM	
SLIP SETS		
VOL-6-500	VOLVO 500 SERIES SLIP SET - L = 340MM, 100MM TUBE	
TUBE YOKES		
VOL-28-400	VOLVO 500 SERIES - 100MM TUBE	
MIDSHIP STUBS		
V8057-500	VOLVO 500 SERIES 69.8MM X 21 SPL, 70MM BRG	
CENTRE BEARINGS		
CB-70198	VOLVO 500 SERIES 70MM, BHC = 198MM	



A product of
Beattys Driveline Technologies

Optimal Performance
Whatever the Challenge



New Zealand

4 Harbour Ridge Drive, Wiri,
Auckland 2104, New Zealand
PO Box 97410, Manukau City,
Auckland, 2241 New Zealand
Phone +64 9 263 7761
Fax +64 9 262 0970
Freephone: 0800 800 852
sales@beattys.co.nz
www.beattys.co.nz

Australia

1-5 Jessica Place, Prestons
NSW 2170 Australia
Phone +61 2 9098 0435
Fax +61 2 8015 6792
Freephone: 1800 463 693
sales@beattys.com.au
www.beattys.com.au